

***can-am***<sup>®</sup>  
**MAVERICK X3**

ACCESSORIES,  
RIDING GEAR &  
GENUINE PARTS

**AUSTRALIAN EDITION**

# YOUR SEARCH FOR THE PERFECT ACCESSORIES STARTS & ENDS HERE

YOUR GUIDE TO ESSENTIAL FACTORY DEVELOPED AND APPROVED  
ACCESSORIES FOR YOUR CAN-AM.



**can-am**



## FIT & COMPATIBILITY

Innovative accessories that are simply better, together. Fit, function and looks—right out of the box—with the peace of mind that the accessories you pick will work perfectly with hundreds of others.



## QUALITY & RELIABILITY

Quality and reliability so good, it comes with a 1-year warranty. We stand strong behind our Genuine Can-Am accessories... because we can. Install them yourself or at an authorized dealer and immediately upgrade your off-road vehicle without worry.



## STYLE & VISION

Can-Am designers develop vehicles and accessories that look and perform right because they're for riders, period. Everything in this guide is here to benefit your experience—nothing else made the cut.

## BRP 1-YEAR LIMITED WARRANTY\*

For new Can-Am accessories, genuine parts, and co-branded products sold through BRP<sup>1</sup>. Includes items installed by you or an authorized BRP dealer.

\*Use other than which the product is designed for will void the product lifetime warranty. <sup>1</sup>Applies only to BRP-made products or co-branded products made by accredited BRP partners (Lonestar Racing for Can-Am, DragonFire for Can-Am, S3 for Can-Am, Beard Seats for Can-Am, Baja Designs for Can-Am, etc.). Purchased at an authorized BRP dealership / distributor or on a BRP-authorized online store. Other exclusions may apply, see complete limited warranty or contact your Can-Am off-road authorized dealer. <sup>2</sup>Includes only BRP-approved aftermarket products and products made by currently accredited BRP partners. <sup>\*\*</sup>Unless otherwise stipulated or required by law. This limited warranty does not apply to factory installed accessories. This limited warranty does not apply on Evinrude parts and accessories. This limited warranty is effective as of March 1<sup>st</sup>, 2016.

# can-am<sup>®</sup>

## MAVERICK X3

### RACE-INSPIRED LONESTAR ROOF

Great graphics and ultimate lightweight aluminum protection

P.11



# 2022

#### 4 ACCESSORIES

4 Built Inspirations

8 Roofs

12 Soft Cabs

13 Windshields & Mirrors

17 Doors

20 Rear Wind Protection

21 Skid Plates

22 Bumpers & Guards

### FULL AIR FLOW CONTROL

From open to closed—and anywhere in between—at the touch of a button.

P.14



[CAN-AMOFFROAD.COM](http://CAN-AMOFFROAD.COM)



## AMPLIFY THE ROTAX ROAR

The uncompromising Yoshimura stainless steel slip-on exhaust is ready to roar.

P.58



## SLEEK PROTECTION

Get quick-entry door handles and most intrusion protection with new Aluminum Half Doors

P.18

- |    |                                     |           |                       |           |                                |
|----|-------------------------------------|-----------|-----------------------|-----------|--------------------------------|
| 30 | Seat Accessories                    | 54        | Performance           | 77        | Dust Masks /                   |
| 32 | LinQ: Easy On Easy Off Cargo        | 61        | Cover & Add-Ons       |           | Communication Systems          |
| 38 | Cargo & Racks                       | 62        | Apache™ Track Systems | 78        | Goggles / Gloves / Junior      |
| 41 | Lights                              | 65        | Promount Plows        | 79        | Bags / Sizing Chart            |
| 47 | Audio & Communication Systems       | 69        | Tires & Rims          | <b>80</b> | <b>PARTS &amp; MAINTENANCE</b> |
| 50 | Electrical & Electronic Accessories | <b>70</b> | <b>RIDING GEAR</b>    | 80        | Genuine Can-Am Parts           |
| 52 | Winches & Hitches                   | 74        | Can-Am Sportswear     | 84        | XPS Oils & Maintenance         |
|    |                                     | 75        | Mud Gear              |           |                                |
|    |                                     | 76        | Helmets               |           |                                |



Look for this logo throughout the catalogue for Expert recommendations on innovative, must-have, enthusiast-ready parts and accessories that will help you customize your perfect off-road machine.

**LinQ**  
SYSTEM

## EQUIP YOUR CAN-AM IN NO TIME

P.32



## ENGINE OIL CHANGE KIT

Want to save time and money? Use the ultra-convenient "all-in-one" DIY Engine Oil Change Kit

P.84



## DUNE

KEEP UP WITH SHIFTING LANDSCAPES  
AND MAXIMIZE YOUR THRILLS: THESE  
ARE THE PERFECT UPGRADES  
FOR DUNE & DESERT RIDING



MAVERICK X3

Take your pick: Expertly-chosen **STARTER**, **ADVANCE**, and **PEAK** performance packages to take your Can-Am build to another level. Or simply mix and match and create your own package.

<b>STARTER</b>	715002909	Half Windshield	P.16
	715004732	Aluminum Half Doors	P.18
	715002961	Dune Front Bumper	P.25
	715002962	Dune Rear Bumper	P.25
	715004778	LinQ 8 GAL (30L) Cooler Box	P.36
	715002882	Yoshimura Slip-on Exhaust	P.58
<b>ADVANCE</b>	+		
	715002881	LinQ Pivoting Rack	P.39
	715004276	Upper Door Storage Bags	P.40
	715003529	Light Support Bar	P.43
	710006821	Baja Designs XL Sport LED Lights	P.42
	710006818	Baja Designs Squadron Sport LED Lights	P.41
<b>PEAK</b>	710006819	10" Baja Designs OnX6 LED Light Bar	P.41
	+		
	715006315	Auxiliary Battery Installation Kit	P.48
	715004900	Audio Roof	P.49
	715002886	Lighted Whip Flag	P.51
	715002874	Electronic Device Holder	P.49

# PERFORMANCE

GET THE MOST POPULAR AND EFFECTIVE PERFORMANCE UPGRADES, FOR THRILLS FROM DAY 1 – & EVERY DAY AFTER



MAVERICK X3

Take your pick: Expertly-chosen STARTER, ADVANCE, and PEAK performance packages to take your Can-Am build to another level. Or simply mix and match and create your own package.

STARTER	715005510	Lonestar Racing Front Bumper	P.27
	715005512	Lonestar Racing Rear Bumper	P.27
	715005514	Lonestar Racing Rock Sliders	P.29
	715002902	Sport Roof	P.9
	715004694	Front Window Nets	P.19
ADVANCE	+		
	715005277	ProVent Windshield	P.15
	715006199	ProVent Roof Module Adapter Kit	P.9
	715005279	ProVent Roof Module Kit	P.9
	715006387	Rear Polycarbonate Window	P.20
PEAK	715005183	In-Line Triple Yoshimura Slip-On Exhaust	P.58
	+		
	715004297	S&B Particle Separator	P.60
	715002873	Complete MTX Audio system	P.48
	715003734	Lonestar Racing Fire Extinguisher Support	P.57
715004866	Lonestar Racing Heavy-Duty Shift Plate & Knob	P.56	
715004865	Lonestar Racing Mud Flaps with Brackets	P.56	

## ADVENTURE

ACCESSORIES THAT TAKE YOU FROM  
ZERO-TO-EXPLORER IN NO TIME

MAVERICK X3 MAX

Take your pick: Expertly-chosen STARTER, ADVANCE, and PEAK adventure packages to take your Can-Am build to another level. Or simply mix and match and create your own package.

STARTER	715003750	Sport Roof MAX	P.9
	715002407	PowerFlip Windshield	P.14
	715003868	Adventure Roof Rack	P.38
	715002973	Fender Flares	P.26
	715006387	Rear Polycarbonate Window	P.20
	+		
ADVANCE	715002903	Front Lower Door Panels	P.19
	715003751	Rear Lower Door Panels	P.19
	715003433	Front Pre-Runner Bumper	P.23
	715003436	Rear Pre-Runner Bumper	P.23
	715003888	Rock Sliders	P.26
	715004007	39" Double Stack LED Light Bar	P.44
	715002873	Complete MTX Audio System	P.48
	+		
PEAK	715003753	Upper Soft Door Panels	P.19
	715003718	HMWPE Skid Plate Protection Kit	P.21
	715004748	MTX Central Speakers	P.48
	295100698	LinQ 4,2 Gal Cooler	P.34
	715004301	LinQ Tool Box	P.34



# OPEN YOUR HORIZONS

Adapt your Maverick X3 to any weather conditions with these **NEW** factory-designed upgrades.



## PROVENT ROOF MODULE KIT

Direct fresh air where you need, when you need it like never before.

SEE P.9

## PROVENT WINDSHIELD

Complete cabin ventilation with factory fit and finish.

SEE P.15



## RADIATOR RELOCATOR

Prepare for deep mud driving or benefit from reduced cabin heat with the radiator relocation.

SEE P.60

## AUDIO ROOF

Powerful roof-mounted next-generation Bluetooth stereo.

SEE P.48



# CAN-AM ROOFS

Made with high-quality materials designed in concert with your Can-Am, our roofs create a strong, light, resilient barrier from the elements.



**FIT & COMPATIBILITY**



**QUALITY & RELIABILITY**



**STYLE & VISION**



**BUILT FOR YOUR VEHICLE**

Engineered with the same design, fit, finish, and built-to-last quality found across our lineup.



**NEW**

## PROVENT ROOF MODULE KIT

Get ultimate air flow and sleek style with our rally-inspired air intake.

**100%  
integrated**

into the design of all Can-Am cab components.



**Make it  
YOURS**

Roof options are the perfect platform for numerous Can-Am accessories that truly transform your Maverick X3.



**SPORT ROOF WITH PROVENT ROOF MODULE KIT**



**SPORT ROOF**

- Impact-resistant injected polypropylene.
- Excellent protection from the elements.
- Provides excellent downhill visibility.
- Windshield compatible.
- Standard on X rs model.

**Maverick X3**

- Easy, tool-less installation and removal with quick-release 1/4 turn fasteners and Velcro straps.

715002902

**Maverick X3 MAX**

- Easy installation.

715003750



**EXPERT CHOICE**

Put a lid on it: The Sport Roof has great visibility, is easy-to-install and is windshield-compatible.

**New PROVENT ROOF MODULE KIT**

- Provides fresh air into the cab area.
- Optimal performance with full cab enclosure.
- 4 vents provide infinite adjustment of air flow for driver and passenger.
- Filter and pre-filter to limit dust intrusion.
- Easy cleaning of filter and pre-filter.
- Patent pending water management system to keep water out of cabin while maintaining air flow.
- Not compatible with roof mounted LED bars, roof racks.
- Outer plug closes air intake completely for winter or heavy weather.
- Requires ProVent Roof Module Adapter Kit (715006199), no requirement for Can-Am Aluminium Roof.

**Maverick X3**

715005279



**New PROVENT ROOF MODULE ADAPTER KIT FOR SPORT ROOF**

(Not illustrated)

- Adapter for fitting ProVent Roof Module Kit onto Maverick X3 Sport Roof.
- Includes roof adapter and hardware.
- Requires ProVent Roof Module Kit (715005279).

**Maverick X3**

715006199

**EXPERT CHOICE**

Add the factory-engineered Provent Roof Module Kit to your Sport roof for a truly fresh take on effective cabin air flow.

**TINTED SUN VISOR**

- Tinted polycarbonate construction.
- Extra protection for driver and passenger from the sun.
- Not compatible with Aluminum Roof and Full Windshields.

**Maverick X3, Maverick X3 MAX**

715003442





**NEW**

**AUDIO ROOF**

Raise the volume with a fully sealed adventure-ready Bluetooth stereo.

P.48

**BIMINI ROOF WITH SUN VISOR**

- Heavy-duty canvas made of UV-resistant solution-dyed polyester.
- Innovative soft top comes with a hard visor that allows for storage of rolled-up soft top.
- Easy, tool-less installation and removal with quick-release 1/4 turn fasteners and Velcro straps.

**Maverick X3**  
715002901

**Maverick X3 MAX**  
715003749

**ALUMINUM ROOF**

- Formed aluminum roof 0.09" (2.3 mm) thick.
- Durable and lightweight.
- Sporty look.
- Windshield compatible.
- Easy and tool-less installation.

**Maverick X3**

■ 715004224 • Black

■ 715002900 • Silver



Some products shown may not be available or homologated in your country. Contact your BRP dealer for local details.



# GIVE YOUR BEAST MORE BACKBONE

AT LONESTAR RACING, IT'S ALL RACE-ENGINEERED, COMPETITION-PROVEN ACCESSORIES.

## LONESTAR RACING ALUMINUM ROOF

- 0.083" (2.1 mm) thick aluminum roof.
- Durable and lightweight.
- Enhances the vehicle's racing appearance thanks to an authentic sporty look combined with unique graphics.
- Offers you protection from the elements with a personalized touch.

- Includes middle intrusion bars for installation.
- Lower profile than other roofs.
- Compatible with Lonestar Racing Light Bar Racks.
- Not compatible LinQ Pivoting Rack, Light Support Bar and with Full Windshields.
- "Lonestar Racing for Can-Am" branded.

Includes middle intrusion bars for installation



Hyper Silver / Black Graphics

Maverick X3 produced after January 1<sup>st</sup>, 2017

- 715005508 • Hyper Silver **New**
- 715005507 • Black **New**

Maverick X3 MAX

- 715005516 • Hyper Silver **New**
- 715005515 • Black **New**



Can-Am Red / Black Graphics

Maverick X3 produced before January 1<sup>st</sup>, 2017

- 715004160 • Can-Am Red

Maverick X3 MAX

- 715004341 • Can-Am Red

Maverick X3 produced after January 1<sup>st</sup>, 2017

- 715004436 • Can-Am Red

# HARSH ELEMENTS DON'T STAND A CHANCE



EASILY REMOVE  
UPPER SOFT DOOR  
PANELS WHEN  
THE WEATHER  
IMPROVES!

## SOFT CAB ENCLOSURE

- Protection for rider and passenger from the elements.
- For added cabin comfort, complete your cab enclosure with Cab Seal Kit.

### Maverick X3

#### Includes:

- Bimini Roof with Sun Visor
- Full Windshield - Hardcoated
- Upper Soft Door Panels
- Front Lower Door Panels
- Soft Rear Window

715003754

### Maverick X3 MAX

#### Includes:

- Bimini Roof with Sun Visor
- Full Windshield - Hardcoated
- Upper Soft Door Panels
- Front Lower Door Panels
- Soft Rear Window

715003755

## CAB SEAL KIT

(Not illustrated)

- Prevents dirt, dust and wind infiltration in the cab area.
- Improves cabin comfort for driver and passenger.
- Recommended with Soft Cab Enclosures.

### Maverick X3

715004433

### Maverick X3 MAX

715004434

## DESIGN YOUR OWN CAB.

PICK THE ACCESSORIES OF  
YOUR CHOICE AND BUILD OR  
COMPLETE YOUR OWN CAB.



100% modular components designed to work together:

**ROOFS** P.8  
**WINDSHIELDS** P.13

**DOORS** P.17  
**REAR WINDOWS** P.20

# CAN-AM WINDSHIELDS

Developed together with your Maverick X3 to ensure they fit, look and perform as they should.



**FIT & COMPATIBILITY**



**QUALITY & RELIABILITY**



**STYLE & VISION**



**BUILT FOR YOUR VEHICLE**

Engineered with the same design, fit, finish, and built-to-last quality found across our lineup.



WINDSHIELDS

ACCESSORIES

## POWERFLIP WINDSHIELD

Allows you to quickly adapt to changing conditions by adjusting the windshield as you go.

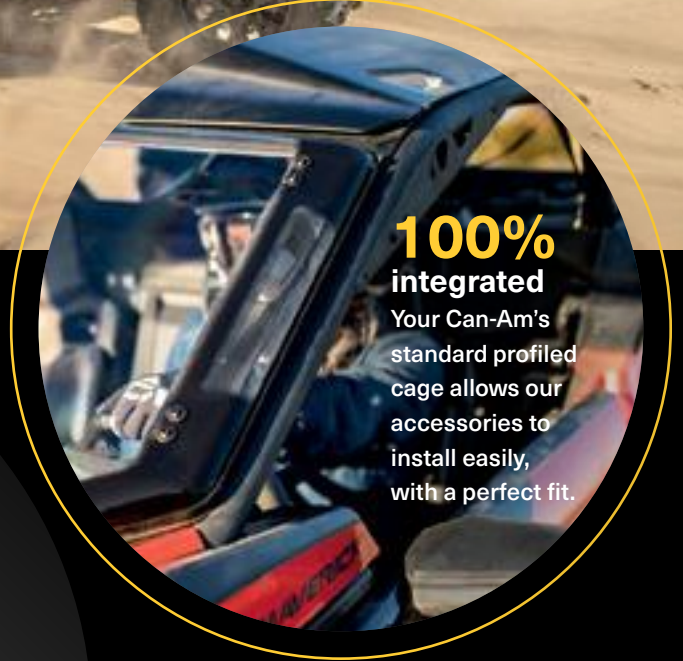

**100% integrated**

Your Can-Am's standard profiled cage allows our accessories to install easily, with a perfect fit.



## Quantum+ Coating

Our Full Windshield - Hardcoated is made of high-impact-resistant Quantum hardcoated polycarbonate to ensure a long life.

## TOTAL AIR FLOW CONTROL

Industry's first POWERED FLIP WINDSHIELD

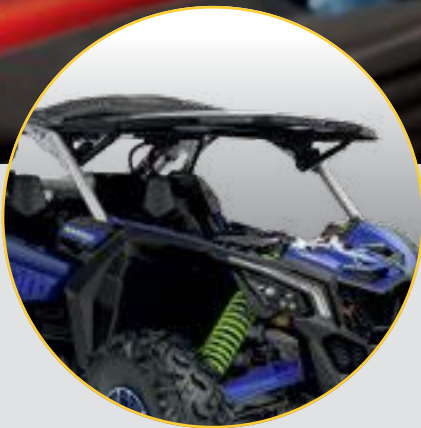

**FULLY OPENED**  
for optimal visibility  
and ventilation



**INFINITE POSSIBILITIES IN BETWEEN**  
depending on protection, visibility  
and air flow preferences

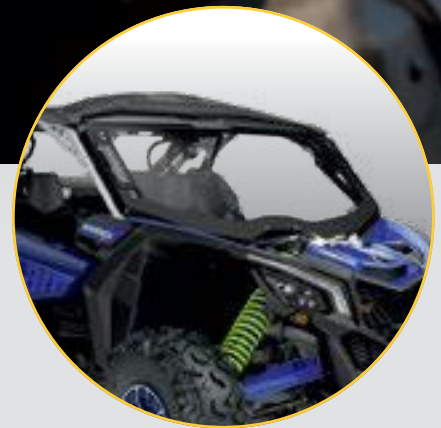

**FULLY CLOSED**  
for maximum protection  
from the elements

### **New** POWERFLIP WINDSHIELD

- The PowerFlip Windshield is equipped with electric cylinders that allow the rider to adjust the windshield opening at the touch of a button.
- Windshield is made of hardcoated polycarbonate with a rubber seal contour and a tinted top section.
- Allows you to quickly adapt to changing conditions by adjusting the windshield as you go.
- Can be fully opened for optimal visibility and ventilation, fully closed for maximum protection from the elements, and in between, you have an infinite number of opening possibilities depending on protection, visibility and air flow preferences.
- Compatible with Can-Am roofs.

**Maverick X3, Maverick X3 MAX**  
715002407



**EXPERT  
CHOICE**

Powerful electric cylinders allow the PowerFlip windshield to open and adjust quickly as you go—at the touch of a button.





### **New** PROVENT WINDSHIELD

- High-impact-resistant Quantum† hardcoated polycarbonate full windshield.
- Controllable vents to manage air flow.
- Optimal performance with full cab enclosure.
- Channels air into the cabin, defogs windshield, fully closes to eliminate air flow.
- One upper vent and one lower vent with pre-filters.
- Formed polycarbonate construction for enhanced rigidity.
- Provides excellent optical clarity and better abrasion resistance.
- Protects driver and passenger from the elements.
- Quick and easy tool-less installation or removal.
- Not compatible with LoneStar Racing roofs.

**Maverick X3, Maverick X3 MAX**

**715005277**

UPPER VENT CHANNELS AIR INTO THE CABIN



LOWER VENTS DEFOG WINDSHIELD



Direct airflow like never before—ProVent redirects wind to where you need it for complete comfort on the go, in any weather.

### GLASS WINDSHIELD

- Curved and laminated glass full windshield.
- Seals firmly against the cage and protects rider and passenger from the elements.
- Provides the best optical clarity and abrasion resistance.
- Must be used with Windshield Wiper & Washer Kit to maintain clear visibility during severe riding conditions, such as mud riding.
- Must be used with rear wind protection.

**Maverick X3, Maverick X3 MAX**

**715003281**



### GLASS WINDSHIELD WITH WIPER & WASHER KIT

- Complete kit that includes the curved and laminated glass windshield with the single-speed wiper and washer fluid dispenser.
- Seals firmly against the cage and protects rider and passenger from the elements.
- An ideal way to keep your windshield clear in rain, or while riding through mud and water.
- Must be used with rear wind protection.

**Maverick X3, Maverick X3 MAX**

**715003283**

### WINDSHIELD WIPER & WASHER KIT

- An ideal way to keep your windshield clear in rain, or while riding through mud and water.
- Includes single-speed wiper and washer fluid dispenser.
- Must be used with the Glass Windshield.
- Wiper mechanism and washer fluid dispenser perfectly concealed within the vehicle.

**Maverick X3, Maverick X3 MAX**

**715004762**





FULL WINDSHIELD -  
HARDCOATED

### FULL WINDSHIELD

- High-impact-resistant durable polycarbonate full windshield.
- Formed polycarbonate construction for enhanced rigidity.
- Formulated to be non-yellowing, non-crazing, non-cracking with excellent UV resistance and optical clarity.
- Protects driver and passenger from the elements.
- Quick and easy tool-less installation or removal.
- Must be used with rear wind protection.

**Maverick X3, Maverick X3 MAX**

715002907



### FULL WINDSHIELD - HARDCOATED

- High-impact-resistant Quantum† hardcoated polycarbonate full windshield.
- Formed polycarbonate construction for enhanced rigidity.
- Provides excellent optical clarity and better abrasion resistance.
- Protects driver and passenger from the elements.
- Quick and easy tool-less installation or removal.
- Must be used with rear wind protection.

**Maverick X3, Maverick X3 MAX**

715004417



### HALF WINDSHIELD

- High-impact-resistant durable polycarbonate half windshield.
- Formed polycarbonate construction for enhanced rigidity.
- Formulated to be non-yellowing, non-crazing, non-cracking with excellent UV resistance and optical clarity.
- Protects driver and passenger from the elements.
- Features reverse angle lip to deflect air flow.
- Quick and easy tool-less installation or removal.

**Maverick X3, Maverick X3 MAX**

### CLEAR WINDSHIELD

715002909



### TINTED WINDSHIELD

715004291



### SIDE MIRRORS

- Rugged cast aluminum mount with black nylon cover.
- Multi-position adjustable ball-joint mounted mirrors.
- Convex optics for a wide viewing angle.
- Spring-loaded pivots let mirrors fold back completely.
- Door mounted.
- Compatible with Upper Soft Door Panels.
- Sold in pairs.

**Maverick X3, Maverick X3 MAX**

715004236 • For stock quarter doors

715005315 • For aluminum doors



### RACING SIDE MIRRORS

- Race-inspired design features rugged black nylon 6/6 construction with coated cast-aluminum mount.
- Dual adjustment provides optimal field of view (FOV).
- Multi-position adjustable ball-joint mounted mirrors.
- Flat optics deliver improved distance perception.
- Spring-loaded pivots let mirrors fold back completely.
- Not compatible with Lonestar Racing Light Racks and Upper Soft Door Panels.
- Sold in pairs.

**Maverick X3, Maverick X3 MAX**

715002898



# CAN-AM DOORS

Dunes, desert, mud & trail—comfort, protection & great looks wherever you roam.



**FIT &  
COMPATIBILITY**



**QUALITY &  
RELIABILITY**



**STYLE &  
VISION**



**PERFECT-FIT**

Choose ultimate fit and rigidity that sits firmly against the cage for complete rider protection from the elements.

DOORS

ACCESSORIES

**NEW**

## ALUMINUM HALF DOORS

Perfect full door coverage in strong, lightweight aluminum — includes Deluxe Door Handles.



**NEW**

## DELUXE DOOR HANDLES

Sturdy inside-outside handles replace door pulls for even faster cockpit entry and exit.

## STAY LOCKED AND LOADED WITH DELUXE EXTERIOR DOOR HANDLES

### **New** ALUMINUM HALF DOORS

- Lightweight half doors made of formed 5/64" (2 mm) thick aluminum.
- Textured black powder coat finish for superior scratch resistance.
- Engineered for maximum rigidity and durability.
- Designed for a perfect fit and seamless integration with the vehicle's lines.
- Contoured with a thick seal for better protection from the elements.
- Easy installation using the standard door frame.
- Include the easy-to-operate Deluxe Door Handles.
- Compatible with the Upper Soft Door Panels, the Window Nets and Upper Door Storage Bags.
- Not compatible with the Lower Door Panel Storage Bags.
- Sold in pairs.

**Maverick X3.**

**Maverick X3 MAX**

715004732 • Front

**Maverick X3 MAX**

715004753 • Rear



### **New** DELUXE DOOR HANDLES

- Convert the standard door straps into easy-to-access door handles.
- Include new inside and outside handles for each door.
- Greatly facilitate door opening.
- Standard on accessory Aluminum Half Doors.
- Sold in pairs.

**Maverick X3, Maverick X3 MAX**

715004758 • Front

**Maverick X3 MAX**

715004860 • Rear

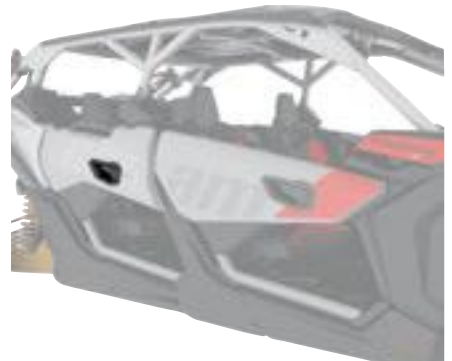
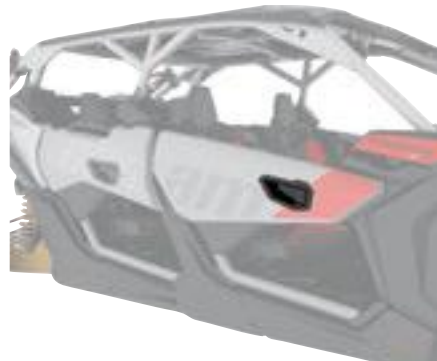

A door handle replacement for getting in and out more easily and faster than ever, available on all Maverick X3 models.



## LOWER DOOR PANELS

- Robust injection-molded polypropylene construction designed to match vehicle.
- Extend stock doors at bottom to protect and seal cab area.
- A great-looking add-on.
- Easy and quick installation.
- Sold in pairs.
- Rear Lower Door Panels sold separately.

**Maverick X3, Maverick X3 MAX**

**715002903 • Front**

**715003751 • Rear**



Front



Rear

## UPPER SOFT DOOR PANELS

- Weather-resistant panels reinforced with aluminum frame offer good protection from the elements.
- Extend stock quarter doors at the top.
- Made of heavy-duty UV-resistant solution-dyed polyester canvas for excellent resistance to tear and abrasion.
- Zip-down windows made of laminated polished vinyl material for added ventilation.
- To be combined with the Lower Door Panels to obtain complete door kits for your vehicle.
- Not compatible with Racing Side Mirrors.

**Maverick X3**

**715003752**

**Maverick X3 MAX**

**715003753**



## WINDOW NETS

- Window mesh screen for added protection from wind.
- Can be easily lowered in seconds
- Sold in pairs.

**Maverick X3**

**715006693 • Front**

**Maverick X3 MAX**

**715004694 • Front**

**715006700 • Rear**



EFFECTIVELY REDUCE  
WIND BACKDRAFTS  
& DEBRIS INTO  
YOUR CAB



**REAR WIND SCREEN**

- Full rear mesh screen reduces windshield backdraft for added cabin comfort.
- Installs quick and easily on roll cage.
- Large white Can-Am logo on black mesh.

Maverick X3 (except X mr models), Maverick X3 MAX  
715006701



**REAR POLYCARBONATE WINDOW**

- High-impact-resistant polycarbonate window.
- Blocks windshield backdraft or dust and rain from entering for added cabin comfort.
- Quick and easy tool-less installation.
- Ready for MTX Audio System Rear Speakers.

Maverick X3 (except X mr models), Maverick X3 MAX  
715006387



**SOFT REAR WINDOW**

- Clear, flexible window made from transparent vinyl.
- Resists cold-cracking to -4°F (-20°C).
- Ideal for preventing backdraft of dust or rain in harsh environments.
- Quick tool-less installation.

Maverick X3 (except X mr models), Maverick X3 MAX  
715006702



Some products shown may not be available or homologated in your country. Contact your BRP dealer for local details.

# HMWPE SKID PLATES

Our Plastic Plates glide smoothly and silently over obstacles, offering great protection in rough terrain. Made of abrasion-resistant thermoformed 3/8" (10 mm) thick High Molecular Weight Polyethylene (HMWPE).

- ✓ Lighter than aluminum
- ✓ Superior stress crack resistance
- ✓ High impact strength

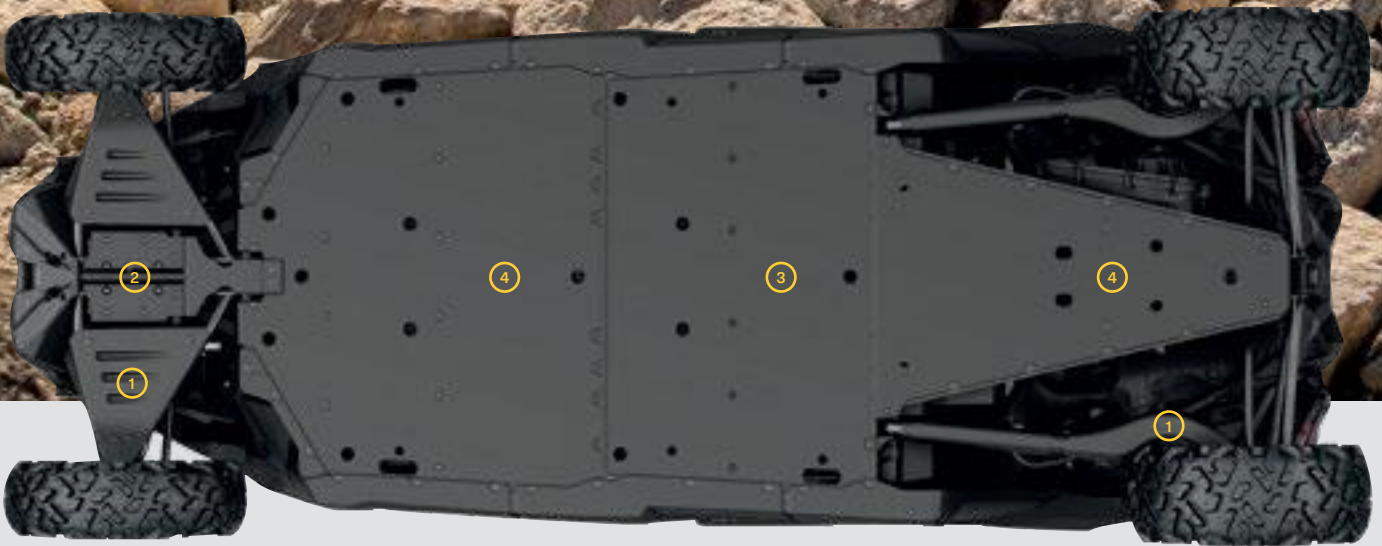

715003731

Offer your Maverick X3 the full protection kit or get them individually. HMWPE skid plates are standard on Maverick X3 X rc models.	Maverick X3 64" Models	Maverick X3 Max 64" Models	Maverick X3, Maverick X3 Max 72" Models (Except Base Models)	Maverick X3 Base 72" Models	Maverick X3 Max Base 72" Models
<b>HMWPE SKID PLATE PROTECTION KIT</b>	715002904	715003747	715003718	715006767	715006769
<b>INDIVIDUAL HMWPE SKID PLATES</b>					
① <b>HMWPE FRONT A-ARM AND TRAILING ARM PROTECTORS</b>	715002905	715002905	715003552	715003552	715003552
② <b>HMWPE FRONT SKID PLATE</b>	715003933	715003933	715003933	715003933	715003933
③ <b>HMWPE CENTRAL SKID PLATE</b>	—	715003731	Standard on these models	—	715003731
④ <b>HMWPE UNDERBELLY PLATE</b>	715004904	715004904	Standard on these models	715004904	715004904

# CAN-AM BUMPERS

Strength and character to endure it all — our bumpers are ready for it.

BUMPERS & GUARDS

ACCESSORIES



**FIT & COMPATIBILITY**



**QUALITY & RELIABILITY**



**STYLE & VISION**



### Better Corrosion Resistance

Can-Am bumpers are E-Coated for supreme corrosion resistance inside and out.



**100%  
integrated**

Seamlessly fit the style and finish of your Maverick X3.



**Light ready**

Fully integrated light mounting plate. Multiple light installation options.



PROTECT & PUSH  
YOUR RIDE WITH  
CONFIDENCE  
THROUGH  
THE WORST



## FRONT PRE-RUNNER BUMPER

- Made of 1.5" (3.8 cm) diameter steel tubing with a 1/8" (3 mm) aluminum plate for extra durability.
- Inside and outside anti-corrosion coating with durable powder coat finish.
- Added heavy-duty protection in extreme driving conditions.
- Integrated winch mounting plate and mount points for lights.

Maverick X3, Maverick X3 MAX

■ 715002878 • Black

■ 715003433 • Can-Am Red



**EXPERT  
CHOICE**

Multi-purposed can look this good:  
Mount lights or a winch with stout protection  
against impacts and long-term corrosion.

## REAR PRE-RUNNER BUMPER

- Extra-durable 1.5" (3.8 cm) diameter steel tubing with a 1/8" (3 mm) aluminum plate.
- Inside and outside anti-corrosion coating with durable powder coat finish.

- Protects vehicle bodywork and exhaust system.
- Rear Receiver Hitch compatible.
- Required for installation of the Rear Cage Extension.

Maverick X3, Maverick X3 MAX

■ 715002880 • Black

■ 715003436 • Can-Am Red





FRONT INTRUSION BAR

### FRONT INTRUSION BAR

- Matches vehicle styling.
- Inside and outside anti-corrosion coating with durable powder coat finish steel intrusion bar.
- Tube design reduces obstructed lines of sight and blind spots for better visibility.
- Not compatible with windshields and Lonestar Racing Aluminum Roof.

**Maverick X3, Maverick X3 MAX**

■ 715002889 • Black

■ 715003435 • Can-Am Red

### REAR CAGE EXTENSION

- Durable 1.5" (3.8 cm) diameter steel tubing.
- Inside and outside anti-corrosion coating with durable powder coat finish.
- Allows holding a spare tire in place (wheel not included).
- Custom tie-down strap for fast tire installation or removal.
- Rear Pre-Runner Bumper required for installation.
- Not compatible with LinQ Pivoting Rack and cargo boxes (except LinQ 20 Gal (73L) Deluxe Modular Bag).

**Maverick X3 (except X mr models), Maverick X3 MAX**

■ 715002890 • Black

■ 715003434 • Can-Am Red



Some products shown may not be available or homologated in your country. Contact your BRP dealer for local details.

DUNE FRONT  
BUMPER

### DUNE FRONT BUMPER

- Made of 1.5" (3.8 cm) diameter aluminum tubing with a 1/8" (3 mm) aluminum plate.
- Inside and outside anti-corrosion coating with durable powder coat finish.
- Provides added protection without sacrificing the agility and performance advantages of a lighter weight design.
- Features a more pronounced attack angle and integrated mounting points for lights.
- Not winch compatible.

**Maverick X3, Maverick X3 MAX**

■ 715002961 • Black

■ 715003432 • Can-Am Red

### DUNE REAR BUMPER

- Made of 1.5" (3.8 cm) diameter aluminum tubing with a 1/8" (3 mm) aluminum plate.
- Inside and outside anti-corrosion coating with durable powder coat finish.
- Provides added protection without sacrificing the agility and performance advantages of a lighter weight design.
- Protects vehicle bodywork and exhaust system.
- Rear hitch compatible.
- Not compatible with Rear Cage Extension and Lonestar Racing Spare Tire Holder.

**Maverick X3, Maverick X3 MAX**

■ 715002962 • Black

■ 715003437 • Can-Am Red



### X RC / X MR FRONT BUMPER

- Made of 1.5" (3.8 cm) diameter steel tubing with a 1/8" (3 mm) aluminum plate.
- Inside and outside anti-corrosion coating with durable powder coat finish on steel tubing.
- Offers all the essential features required for technical driving: Low front end protection, support base for winch installation and integrated tow hook.
- Standard on Maverick X3 X rc and X mr models.
- Not compatible with winches with steel cable.

**Maverick X3, Maverick X3 MAX**

■ 715004741 • Sunburst Yellow

■ 715004788 • Black

■ 715004742 • Octane Blue

■ 715004789 • Can-Am Red





## FENDER FLARES

- Extended fender flares made from injection-molded polypropylene.
- Keep mud and debris out of vehicle.
- Designed for quick and easy installation.
- Include front and rear extensions and mounting hardware.

**Maverick X3, Maverick X3 MAX**

715002973



## ROCK SLIDERS

- Made of heavy-duty 1.5" (3.8 cm) diameter steel tubing.
- Inside and outside anti-corrosion coating with durable powder coat finish.
- Protect vehicle's sides and undercarriage against large obstacles.
- Support plate adds rigidity and style.
- Sold in pairs.

**Maverick X3 (except X rc)**

■ 715002963 • Black

■ 715003438 • Can-Am Red

**Maverick X3 MAX**

■ 715003730 • Black

■ 715003888 • Can-Am Red



## X RC UHMWPE ROCK SLIDERS

- Robust 1/4" (6 mm) UHMWPE construction.
- Include new lower body panels and brackets for installation.
- Protect vehicle's sides and undercarriage against large obstacles.
- Lodge tight up against vehicle body for better clearance from obstacles.
- Slide smoothly over obstacles.
- Sold in pairs.

**Maverick X3**

715004730



*Some products shown may not be available or homologated in your country. Contact your BRP dealer for local details.*



**RACING DESIGN FOR PEAK PERFORMANCE**

Race-engineered with a reputation for toughness and style.



**LONESTAR RACING FRONT BUMPER**

- Made of 1.5" (3.8 cm) diameter steel tubing with durable powder coat finish and a 1/8" (3 mm) thick aluminum plate for added vehicle-front protection in extreme driving conditions.
- Sleek styling enhances the vehicle's race-inspired look.
- Not winch compatible.
- Not compatible with 10" (25 cm) Baja Designs OnX6 LED Light Bar.



**Maverick X3, Maverick X3 MAX**

715005510 • Hyper Silver **New**

715005509 • Black **New**

**LONESTAR RACING REAR BUMPER**

- Made of 1.5" (3.8 cm) diameter steel tubing with durable powder coat finish.
- Provides additional vehicle-rear bodywork and exhaust system protection in extreme driving conditions.
- Sleek styling enhances the vehicle's race-inspired look.
- Compatible with Lonestar Racing Spare Tire Holder and Lonestar Racing Rear Intrusion Bar.
- Not hitch compatible.



**Maverick X3, Maverick X3 MAX**

715005511 • Black **New**

715005512 • Hyper Silver **New**



**Maverick X3, Maverick X3 MAX**

715004161 • Can-Am Red



**Maverick X3, Maverick X3 MAX**

715004162 • Can-Am Red



### LONESTAR RACING FRONT INTRUSION BAR

- Made of 1.5" (3.8 cm) diameter steel tubing with durable powder coat finish.
- Enhances the racing look of the vehicle.
- Compatible with Lonestar Racing Aluminum Roof only.
- Not compatible with windshields.

**Maverick X3, Maverick X3 MAX**

- 715003916 • Black
- 715004163 • Can-Am Red
- 715006342 • Hyper Silver **New**

### LONESTAR RACING REAR INTRUSION BAR

- Made of 1.5" (3.8 cm) diameter steel tubing with durable powder coat finish.
- Sleek styling enhances the vehicle's race-inspired look.
- Required for the installation of the Lonestar Racing Spare Tire Holder.
- Not compatible with LinQ mounted accessories and Pre-Filter in the cargo bed.

**Maverick X3 (except X mr models), Maverick X3 MAX**

- 715003918 • Black
- 715004164 • Can-Am Red
- 715006343 • Hyper Silver **New**



### LONESTAR RACING SPARE TIRE HOLDER

- Made of 1.5" (3.8 cm) diameter steel tubing with durable powder coat finish.
- Adjustable height to fit Can-Am tires up to 30 in.
- Requires Lonestar Racing Rear Bumper and Lonestar Racing Rear Intrusion Bar for installation.
- Cannot hold the Pro Armor Quickshot Wheel Jack and Off-Road Screw Jack.
- Wheel not included.
- Not compatible with the S&B Particle Separator and LinQ accessories intended for the rear of the vehicle.

**Maverick X3 (except X mr models), Maverick X3 MAX**

- 715003922 • Black
- 715004166 • Can-Am Red
- 715006344 • Hyper Silver **New**



### LONESTAR RACING NUMBER PLATE HOLDER

- Includes a pair of sturdy aluminum number plates that mount on either side of the vehicle rear.
- Not compatible with LinQ Pivoting Rack.
- Numbered decals are available through SCS Unlimited.

- Styling enhances the vehicle's race-inspired look while adding a personal touch.
- Black background.

**Maverick X3, Maverick X3 MAX**

715003943





USE & PROTECT EVERY INCH FOR THE BOLDEST ADVENTURES

### LONESTAR RACING ROCK SLIDERS

- Made of 1.5" (3.8 cm) diameter steel tubing with durable powder coat finish filled with 1/8" (3 mm) aluminum plate.
- Protects vehicle sides from large obstacles.
- Sleek styling enhances the vehicle's race-inspired look.
- Sold in pairs.



**Maverick X3**

715005514 • Hyper Silver **New**    715005513 • Black **New**



**Maverick X3 MAX**

715005518 • Hyper Silver **New**    715005517 • Black **New**



**Maverick X3**

715004165 • Can-Am Red



**Maverick X3 MAX**

715004343 • Can-Am Red



FOR **can-am**



S3 REAR BUMPER



S3 FRONT BUMPER

WHEN IT COMES TO MUD-MASTERING ACCESSORIES, **S3** HAS THE EDGE IN DELIVERING PERFECT-FIT WINCH-READY BUMPERS FOR WORK, PLAY, AND RECOVERY

#### **New** S3 FRONT BUMPER

- Made of 1.5" (3.8 cm) diameter steel tubing with a 1/8" (3 mm) aluminum plate for extra durability.
- Inside and outside anti-corrosion coating with durable powder coat finish.
- Added heavy-duty protection in extreme driving conditions.
- Integrated winch support plate and mount points for lights.
- Hook support anchor allows you to keep the winch hook within easy reach when riding in deep mud.
- "S3 for Can-Am" branded.
- Winch Not Included.

**Maverick X3, Maverick X3 MAX**

- 715004867 • Black
- 715005231 • Can-Am Red

#### **New** S3 REAR BUMPER

- Made of extra-durable 1.5" (3.8 cm) diameter steel tubing.
- Inside and outside anti-corrosion coating with durable powder coat finish.
- Added heavy-duty protection in extreme driving conditions - protects vehicle bodywork and exhaust system.
- Permits installation of a Winch at a higher location to improve accessibility in muddy conditions.
- "S3 for Can-Am" branded.

**Maverick X3, Maverick X3 MAX**

- 715004869 • Black
- 715005232 • Can-Am Red

- Engineered to sustain heavy winch loads without damaging the vehicle's frame.
- Compatible with Can-Am HD and WARN VRX winches - Rear Winch Harness 715006007 is required to install a Winch on the Bumper.
- Includes a robust recovery hook to facilitate vehicle recovery.
- Winch Not Included.
- Not EC compliant.

#### **New** S3 REAR PULL PLATE

- Offers a solid place to hook onto in case towing is needed.
- Allows you to attach most straps and hooks.
- "S3 for Can-Am" branded.

**Maverick X3, Maverick X3 MAX**

- 715004870 • Black
- 715005233 • Can-Am Red

#### REAR WINCH HARNESS

(Not illustrated)

715006007







## 4-POINT HARNESS

- Exclusive controlled decelerator absorbs energy in case of an accident.
- Designed to offer maximum riding comfort.
- Easy one-click latch and release.
- Patent pending.
- Not EC compliant.

**Maverick X3, Maverick X3 MAX**

**715003767 • Passenger**

**715003766 • Driver**



## SEAT BELT SHOULDER PADS

- Provide additional riding comfort by preventing seat belt from rubbing on neck and shoulder.
- Fit with standard 3-point seat belts and Retractable 4-Point Harness.
- Easy Velcro installation.
- Can-Am branded.
- Sold in pairs for driver and passenger.

**Maverick X3, Maverick X3 MAX**

**715002894**



## RETRACTOR PROTECTOR

(Not illustrated)

- Protective pad required for the installation of the Retractable 4-Point Harness on front seat of MAX models.
- Protects the passengers from the retractor mechanism.
- Sold individually.

**Maverick X3 MAX**

**707900653**

## RETRACTABLE 4-POINT HARNESS

- Convenient harness allows you to move freely in your seat, and at the same time, fully benefit from the extra support given by the 4-point attachments.
- Makes it easier to buckle up and requires fewer adjustments when switching passenger or driver.
- Retractor Protector (707900653) is required for installation on front seats of MAX models.
- Compatible with rear passenger seats on MAX models.
- Standard on Maverick X3 Xrs 2018 and up and X rc Turbo R models.

**Maverick X3, Maverick X3 MAX**

**715005022 • Passenger**

**715005021 • Driver**



# LinQ SYSTEM™

## EASY ON EASY OFF CARGO

A BRP exclusive, LinQ is a tool-less system for near-instant installation of accessories. Quickly, easily install and remove LinQ accessories to transform your machine for the moment.



FIT &  
COMPATIBILITY



QUALITY &  
RELIABILITY



STYLE &  
VISION



### TOOL-LESS

Twist LinQ fasteners and go!



### YOUR ADVENTURE, OUTFITTED

LinQ trunk boxes, rack extensions, bags, baskets, and gear grips attach quickly for your next expedition.





### LinQ ACCESSORY TYPES

- **LinQ** with 16" base accessories are mounted with LinQ anchors 16 inches apart, ideal for Can-Am ATVs and SSVs, Sea-Doo watercraft, and Ski-Doo snowmobiles.
- **LinQ** with 36" base accessories are most commonly used as part of LinQ racks for Can-Am Off-Road vehicles.







# LinQ SYSTEM™ ACCESSORIES

- No tools needed: Quickly install and remove accessories by hand
- Equip your Can-Am for specialized tasks in no time
- Sturdy mounting system that holds up to the roughest terrain

Mounting location and requirements		
<b>Standard LinQ Rack</b> 	<b>LinQ Pivoting Rack</b> 715002881 / 715003439 	<b>Adventure Roof Rack</b> 715003868 









## LinQ ACCESSORIES WITH 16" BASE P. 35

- LinQ anchors mounted 16 inches apart, center-to-center.
- Lower loading capacity than the LinQ with 36" base accessories.
- Can be used on Can-Am ATV and SSV vehicles, Sea-Doo watercraft and Ski-Doo snowmobiles.

	<b>LinQ 4.2 GAL (16 L) COOLER</b> 295100698	<b>LinQ Anchor Adapter Kit</b> 715004960	<b>LinQ Anchor Adapter Kit</b> 715004960	<b>LinQ Cargo Base Kit</b> 860201806
	<b>LinQ TOOL BOX</b> 715004301			No further requirements
	<b>LinQ SR 5.5 GAL (21 L) BAG</b> 860201740			
	<b>LinQ 4.5 GAL (17 L) SPORT BAG</b> 860201678			
	<b>New LinQ DRY BAG</b> 715002875			

## LinQ ACCESSORIES WITH 36" BASE P. 36-37

- Mount on LinQ racks often used by Can-Am ORV vehicles.
- Higher loading capacity than the LinQ with 16" base accessories.
- Usage is limited to Can-Am ORV vehicles.

	<b>LinQ 12 GAL (45L) CARGO BOX</b> 715003879	No further requirements	No further requirements	Not compatible
	<b>LinQ 23 GAL (86L) TRUNK BOX</b> 715004923	No further requirements *Not compatible if the LinQ Pivoting Rack is installed.		
	<b>LinQ 32 GAL (124L) TRUNK BOX</b> 715001748			
	<b>LinQ 11.5 GAL (43L) AUDIO CARGO BOX</b> 715003018	No further requirements		
	<b>LinQ 8 GAL (30L) COOLER BOX</b> 715004778 • Black / 715004698 • Grey			
	<b>LinQ PREMIUM STORAGE BAG BY OGIO</b> 715002923 • Black / 715003248 • Camo	No further requirements		
	<b>LinQ HEAVY-DUTY BASKET</b> 715001215	No further requirements		
	<b>LinQ LOW PROFILE BASKET</b> 715004282			

## LinQ RACKS & HOLDERS P. 42

	<b>LinQ TOOL HOLDER</b> 715003059	No further requirements	No further requirements	Side wall installation: <b>LinQ Adapters</b> 715003058
---	--------------------------------------	-------------------------	-------------------------	--

LinQ 4.2 GAL (16 L)  
COOLERSR 5.5 GAL (21L)  
LinQ BAGLinQ TOOL  
HOLDER  
P.37

## LinQ ACCESSORIES WITH 16" BASE

**LinQ 4.2 GAL (16 L) COOLER**

- Rotomolded construction for exceptional rigidity and durability.
- Premium-quality foam insulation for optimal ice retention.
- Maritized for salt water purposes.
- See table for installation location and requirements.

**Maverick X3, Maverick X3 MAX**  
295100698



**EXPERT  
CHOICE**

One of the most versatile and popular coolers on the market made for rugged use.

**LinQ TOOL BOX**

- High precision injected HDPE construction provides rigidity and durability.
- 5 Gal (19 L) maximum capacity.
- Weather-resistant, sealed and lockable cover.
- LinQ Cargo Base Kit (860201806) included.
- Maritized for salt water purposes.
- See table for installation location and requirements.

**Maverick X3, Maverick X3 MAX**  
715004301

**LinQ SR 5.5 GAL (21 L) BAG**

- Semi-rigid expandable bag.
- 5.5 Gal (21L) capacity.
- LinQ Cargo Base Kit included (860201806) included.
- See table for installation location and requirements.

**Maverick X3, Maverick X3 MAX**  
860201740

**New LinQ 4.5 GAL (17 L) SPORT BAG**

- 4.5 Gal (17 L) capacity.
- Rigid bottom, semi-rigid top.
- See table for installation location and requirements.

**Maverick X3, Maverick X3 MAX**  
860201678

**New LinQ DRY BAG**

- Fully waterproof roll-top dry bag will securely store and confine your equipment.
- LinQ mounted using heavy-duty rigid plastic base.
- High capacity storage solution (40L).
- Bottom foam liner for additional equipment protection.
- Integrated handle for easy transportation on/off the vehicle.
- LinQ Cargo Base Kit included (860201806) included.
- Maritized for salt water purposes.
- See table for installation location and requirements.

**Maverick X3, Maverick X3 MAX**  
715002875





LinQ 23 GAL (86L) TRUNK BOX



**LinQ ACCESSORIES WITH 36" BASE**

**LinQ 12 GAL (45L) CARGO BOX**

- LinQ mounted for easy on, easy off installation.
- Holds cargo safely and securely while riding.
- See table for installation location and requirements.

**Maverick X3, Maverick X3 MAX**  
715003879



**LinQ 23 GAL (86L) TRUNK BOX**

- LinQ mounted for easy on, easy off installation.
- Lockable and weather-resistant.
- Holds cargo safely and securely while riding.
- See table for installation location and requirements.

**Maverick X3 (except X mr models), Maverick X3 MAX**  
715004923



**LinQ 32 GAL (124L) TRUNK BOX**

- Equipped with the LinQ System, the rear trunk box plugs in and out in seconds.
- 32 Gal (124L) load capacity with unobstructed space to maximize storage room and access to the trunk's interior.
- Made of injection-molded polyethylene, double walled in critical areas.
- The fully sealed lid protects your belongings from dust, moisture and the elements.
- No rear tail light.
- Trunk Box Panels available in many colors to match your vehicle (sold separately).
- See table for installation location and requirements.

**Maverick X3 (except X mr models), Maverick X3 MAX**  
715001748 • No rear tail light



**LinQ 32 GAL (124L) TRUNK BOX PANELS**

- Fit LinQ 32 Gal (124L) Trunk Box.
- Color panels to match the LinQ 32 Gal (124L) to your vehicle.
- European Version (EC compliant)
- No rear tail light.

**Maverick X3, Maverick X3 MAX**  
■ 715006121 • Can-Am Red  
■ 715006122 • Manta Green  
■ 715006123 • Orange Crush  
■ 715006124 • Viper Red

■ 715001397 • Black  
■ 715001398 • Yellow  
■ 715002482 • Light Grey  
■ 715002483 • White





LinQ 8 GAL (30L)  
COOLER BOX



## LinQ ACCESSORIES WITH 36" BASE

### LinQ 11.5 GAL [43L] AUDIO CARGO BOX

- An affordable and quick solution for adding music and storage to your next ride.
- The rear installation does not use any cab space and allows for easy listening at an average speed.
- Mounts on/off easily to hold/carry cargo safely and securely.
- Backlit control panel perfect for night riding.
- Water-resistant speakers.
- The Bluetooth enabled receiver and 6.5" (16.5 cm) speakers are smartly concealed and integrated in the cover.
- Automatic shut-off function protects your battery by turning the system off after 10 minutes of inactivity.
- See table for installation location and requirements.

**Maverick X3, Maverick X3 MAX**

715003018



### LinQ 8 GAL [30L] COOLER BOX

- Installs without vehicle modification.
- LinQ mounted for easy on, easy off installation.
- Rotomolded construction provides exceptional rigidity and durability.
- Premium-quality foam insulation for optimal ice retention.
- Weather-resistant.
- Integrated, fully-removable compartment protects food.
- Robust rubber latches keep the cover tightly closed.
- Convenient drain plug.
- See table for installation location and requirements.

**Maverick X3, Maverick X3 MAX**

■ 715004778 • Black

■ 715004698 • Grey



**EXPERT  
CHOICE**

Premium insulation keeps ice and contents cooler, longer.



**LinQ ACCESSORIES WITH 36" BASE**

**LinQ PREMIUM STORAGE BAG BY OGIO**

- Tool-less installation and removal thanks to the LinQ System.
- 17.2 Gal (65 L) capacity semi-rigid cargo bag ideal for carrying anything you need on your vehicle.
- Buckle and elastic closure with a rubber seal that protects dust from entering the bag.
- 3-section lid for partial or full access to your bag.
- Inside separators for optimal bag organization.
- See table for installation location and requirements.

**Maverick X3, Maverick X3 MAX**

715002923 • Black

715003248 • Mossy Oak Break-Up Country Camo



Inside separators for optimal bag organization

**LinQ HEAVY-DUTY BASKET**

- Made of high-strength, low-alloy steel.
- LinQ mount for easy on, easy off installation.
- See table for installation location and requirements.

**Maverick X3, Maverick X3 MAX**

715001215



**LinQ LOW PROFILE BASKET**

- Low profile, open basket increases cargo space.
- Perfect for easy access to tools, rope, winch and plow accessories.
- Multiple bungee cord and tie-down anchor points.
- Made of impact-resistant injected polypropylene.
- See table for installation location and requirements.

**Maverick X3, Maverick X3 MAX**

715004282



**LinQ RACKS & HOLDERS**

**LinQ TOOL HOLDER**

- Ultra-versatile tool holder.
- Convenient swivel-latch allows tools to be stored in any orientation.
- Sold in pairs.
- See table for installation location and requirements.

**Maverick X3, Maverick X3 MAX**

715003059



**New LinQ ANCHOR ADAPTER KIT**

- Allows the installation of 16" LinQ accessories.
- Tool-less installation and removal.

**Maverick X3, Maverick X3 MAX**

715004960



**LinQ CARGO BASE KIT**

- Unique mounting fastener usable on any LinQ System accessory.
- Included: 2 LinQ Cargo bases and hardware.

**Maverick X3 MAX**

860201806



**TUBE LinQ ADAPTER**

- Cage mounted LinQ receiver.
- Included in the LinQ Pivoting Rack assembly.
- Allows the installation of single LinQ mounted accessory.
- Diameter: 1.85" (47 mm).

**Maverick X3, Maverick X3 MAX**

715004292



**LinQ REPLACEMENT PART**

- (Not illustrated)
- Unique mounting fastener usable on any LinQ System accessory.
- Tool-less installation and removal.
- Sold in pairs.

**Maverick X3, Maverick X3 MAX**

715001707

**LinQ ADAPTER**

- (Not illustrated)
- Allows the installation of the LinQ Tool Holder (715003059) on the Adventure Roof Rack.
- Sold in pack of 4.

**Maverick X3 MAX**

715003058



### BUILD YOUR OWN ADVENTURE ROOF RACK!

Shown here with:  
SPARE TIRE WITH TIE-DOWNS  
BAJA DESIGNS XL80 LED LIGHTS AND  
LinQ TOOL HOLDERS

#### ADVENTURE ROOF RACK

- Ideal cargo solution for packing everything you need to live your off-road experience fully and completely.
- Built with lightweight 1.25" (3.2 cm) diameter steel tubing.
- Loads of up to 75 lb (34 kg).
- Integrated mounting points for lights can hold up to 8 pod-type LED lights (6 front and 2 back) or a 40" (102 cm) LED bar (front).
- Features anchor points for spare tire attachment.
- Spare Tire Tie-Downs sold separately.
- Add the Cargo Box Net or the Cargo Box Elastic Net to secure and confine your cargo in the rack.
- See table for installation location and requirements.

**Maverick X3 MAX**

715003868



#### SPARE TIRE RATCHET TIE-DOWNS

- 3-way ratcheting tie-down strap with loop ends.
- Designed to securely hold spare tires on accessories equipped with integrated spare tire attachment points.
- Adjustable to accommodate most common UTV tire sizes.
- Ratchet and junction ring made of durable zinc-plated steel.
- Required for spare tire attachment on Adventure Roof Rack.

**Maverick X3 (except X mr models).**

**Maverick X3 MAX**

28000606



**EXPERT  
CHOICE**

Next-generation Adventure Roof Rack mounts securely and features light mounts, anchor points and cargo space for any off-road journey.





LinQ PIVOTING RACK



**LinQ RACKS & HOLDERS**

**LinQ PIVOTING RACK**

- LinQ latched rack allows for extra LinQ mounted accessories or for carrying a spare tire (tire not included).
- Includes custom tie-down strap for fast spare tire installation or removal.
- Gas-cylinder pivot action, locks in the raised position.
- Trunk Boxes over 20 Gal (74L) do not fit on the vehicle when the rack is installed.
- Not compatible with Rear Intrusion Bars, Rear Cage Extension and Lonestar Racing Aluminum Roofs.

Maverick X3 (except X mr models), Maverick X3 MAX

■ 715002881 • Black

■ 715003439 • Can-Am Red



With the LinQ Pivoting Rack, bring along cargo without giving up your trunk box!



**OVERHEAD STORAGE BAG**

- Weather-resistant bag, holds your gear safely and securely while riding.
- Makes smart use of your overhead space to increase your vehicle's cargo capacity by 2.6 Gal (10L).
- Semi-rigid construction renders it flexible enough to fit odd-shaped loads.
- Touchscreen-compatible clear front pocket allows for easy access to your smartphone.
- Not compatible with the Bimini Roof.

Maverick X3, Maverick X3 MAX

715004275





## SHOULDER STORAGE BAGS

- Weather-resistant bag, holds your gear safely and securely while riding.
- Designed as a 2 Gal (7.6L) capacity pocket, also equipped with inner netting compartments.
- Semi-rigid construction renders it flexible enough to fit odd-shaped loads.
- Installs between the driver and passenger seats on MAX models.
- Not compatible with Beard Seats.

### FRONT SHOULDER STORAGE BAG

- Opens on each side so that both front and rear passengers can access the bag's content.
- Installs between the driver and passenger seats on MAX models.

**Maverick X3 MAX**

715004888



### SHOULDER STORAGE BAG

- Bag attaches in unused space between the seats to increase your vehicle's cargo capacity.
- Installs between the rear seats only on MAX models.

**Maverick X3 (except X mr models), Maverick X3 MAX (rear only)**

715004277



### LOWER DOOR PANEL STORAGE BAGS

- Weather-resistant, they'll hold your gear safely and securely while riding.
- Bags attach on Lower Door Panels to increase your vehicle's cargo space.
- Each bag is designed as a 1.6 Gal (6L) capacity pocket also equipped with inner netting compartments.
- Semi-rigid construction renders them flexible enough to fit odd-shaped loads.
- Sold in pairs.
- Not compatible with aluminum doors and Off-Road Screw Jack.
- Lower add-on doors required for installation.

**Maverick X3, Maverick X3 MAX**

715004355



### UPPER DOOR STORAGE BAGS

- Weather-resistant, they'll hold your gear safely and securely while riding.
- Bags attach on stock quarter doors to increase your vehicle's cargo space.
- Each bag is designed as a 1.3 Gal (5L) capacity pocket also equipped with inner netting compartments.
- Semi-rigid construction renders them flexible enough to fit odd-shaped loads.
- Sold in pairs.

**Maverick X3, Maverick X3 MAX**

715004276



**EXPERT CHOICE**

Add weather-resistant interior storage with our semi-rigid bags.

### STORAGE 2.6 GAL (10L) BAG

- Roll-top dry bag for fully protecting your cargo from the elements.

**Maverick X3, Maverick X3 MAX**

269502121



### SOFT STORAGE BAG

(Not illustrated)

- 11.8 Gal (45L) capacity soft cargo bag designed with vehicle's rear in mind to maximize potential storage.
- 3 sections.
- Weatherproof.

**Maverick X3, Maverick X3 MAX**

715003759 • Black



DEVELOPED BY THE SCIENTISTS OF LIGHTING TO SHINE FARTHER AND SURVIVE BEYOND THE BEATEN PATH—ALL WITH A LIFETIME WARRANTY.

**40" [102 CM] BAJA DESIGNS ONX6 ARC LED LIGHT BAR**

- 252W light bar producing 39,220 lumens.
- Equipped with 24 Cree XM-L2 LEDs.
- Driving/Combo light pattern for smooth blend of light for both near field applications and distance.
- Designed for installation onto Light Support Bar equipped roofs.
- Requires Light Power Cable and Light Support Bar.

**Maverick X3, Maverick X3 MAX**  
710006818



**29,000 LUMENS**

**40" [102 cm] ONX6 ARC COMBO**

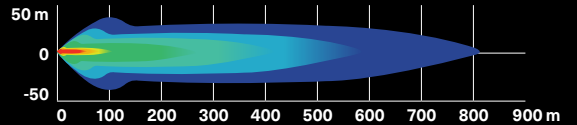

Updated light bar from Baja Designs throws a clear and crisp 39,220 lumens.

**10" [25 CM] BAJA DESIGNS ONX6 LED LIGHT BAR**

- 58.5W light bar producing 7,350 lumens.
- Equipped with 6 Cree XM-L2 LEDs.
- Driving/Combo light pattern for smooth blend of light for both near field applications and distance.
- Dual intensity (high/low) settings.
- Designed for installation onto Pre-Runner and Dune bumpers and/or Light Support Bar equipped roofs.
- Requires Light Power Cable.

**Maverick X3, Maverick X3 MAX**  
710006819



**12,460 LUMENS**

**10" [25 cm] ONX6 COMBO**

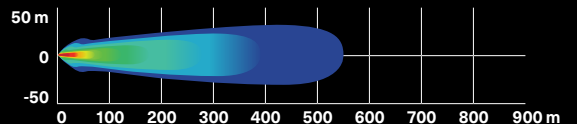



### BAJA DESIGNS XL SPORT LED LIGHTS

- 20W per spot producing 1,800 lumens.
- Equipped with 4 Cree XP-G2 LEDs per spot.
- High Speed Spot features a longer and narrower beam focus for illumination farther down.
- Designed for installation onto Pre-Runner and Dune bumpers and/or Light Support Bar equipped roofs.
- Require Light Power Cable.
- Sold in pairs.
- Dimensions: 4.5" x 4.5" (11.4 cm x 11.4 cm).

**Maverick X3, Maverick X3 MAX**

710006821



1,800 LUMENS

#### XL SPORT SPOT

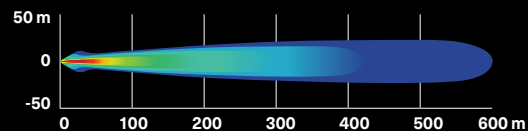

### BAJA DESIGNS SQUADRON SPORT LED LIGHTS

- 20W per spot producing 1,800 lumens.
- Equipped with 4 Cree XP-G2 LEDs per spot.
- Designed for installation onto Pre-Runner and Dune bumpers and/or Light Support Bar equipped roofs.
- Wide cornering light pattern designed specifically for cornering, dust and/or fog conditions.
- Require Light Power Cable.
- Sold in pairs.
- Dimensions: 3" x 3" (7.6 cm x 7.6 cm).

**Maverick X3, Maverick X3 MAX**

710006820



1,800 LUMENS

#### SQUADRON SPORT WIDE CORNERING

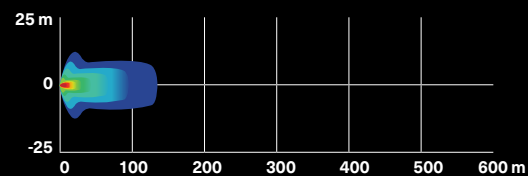

### BAJA DESIGNS XL80 LED LIGHTS

- 80W per spot producing 9,500 lumens.
- Equipped with 4 Cree XHP50 LEDs per spot.
- Dual intensity (high/low) settings.
- Driving/Combo light pattern for smooth blend of light for both near field applications and distance.
- Designed for installation onto Pre-Runner and Dune bumpers and/or Light Support Bar equipped roofs.
- Require Light Power Cable.
- Sold in pairs.
- Dimensions: 4.5" x 4.5" (11.4 cm x 11.4 cm).

**Maverick X3, Maverick X3 MAX**

710005041



9,500 LUMENS

#### XL80 COMBO

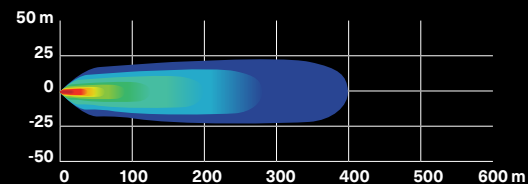

**BUILD YOUR LIGHTING SYSTEM. REFER TO PAGE 46**

*Some products shown may not be available or homologated in your country. Contact your BRP dealer for local details.*

### LONESTAR RACING LIGHT RACK



## LOW-PROFILE LIGHT MOUNT SOLUTION FROM LONESTAR RACING

### LONESTAR RACING 40" (102 CM) LED LIGHT BAR RACK

- Designed for use with 40" (102 cm) Baja Designs OnX6 Arc LED Light Bar.
- Enhances the vehicle's race-inspired look.
- Compatible with Aluminum Roof, Lonestar Racing Aluminum Roof and Sport Roof.
- Not compatible with Racing Side Mirrors and PowerFlip Windshield.
- Lights sold separately.

**Maverick X3, Maverick X3 MAX**

715003920



### LONESTAR RACING LIGHT RACK

- Designed for use with Baja Designs XL80 LED Light and Baja Designs XL Sport LED Light.
- Accommodates up to two pairs of XL Lights.
- Not compatible with Racing Side Mirrors and PowerFlip Windshield.
- Compatible with Lonestar Racing Aluminum Roof, Aluminum Roof and Sport Roof.
- Lights sold separately.

**Maverick X3, Maverick X3 MAX**

715003948



### CHASE LIGHTS

- Designed by Can-Am to make you visible to vehicles riding behind you, especially in dusty or harsh conditions.
- Feature in-dash switches to activate one of the two modes and to choose among 11 different high-visibility colored light patterns (blue, red and yellow).
- Trail Mode: Serves as a tail light and as a brake light.
- Race Mode: Displays light patterns and serves as a brake light (brake light function can be deactivated for racing applications).
- Modular to allow installation with rear roll cage mounted accessories.
- Plug-and-play installation.

**Maverick X3, Maverick X3 MAX**

715002887



### LIGHT SUPPORT BAR

- Sleekly-styled rugged aluminum construction.
- Accommodates light bars and spotlights with or without any roof and windshield combination.
- Full vehicle width to allow the installation of any large LED light bar.
- Required for light installation on vehicle's roof.
- Not compatible with Lonestar Racing Aluminum Roof.
- Lights sold separately.

**Maverick X3, Maverick X3 MAX**

715003529



### MOUNTING KIT FOR 39" (99 CM) LED LIGHT BAR

(Not illustrated)

- Required for installation of the 39" (99cm) Double Stacked LED Light Bar.
- Includes wiring and support bracket.
- Light Support Bar required for installation.

**Maverick X3, Maverick X3 MAX**

715005822

### LIGHT POWER CABLE

(Not illustrated)

- Required for installation of 10" (25 cm), 15" (38 cm) and Double Stacked LED Light Bars and 4" (10 cm) Round LED Lights.
- For bumper and roof mounting locations.

**Maverick X3, Maverick X3 MAX**

715003417



### 39" [99 CM] DOUBLE STACKED LED LIGHT BAR [270 WATTS]

- Equipped with 54 5W Cree LEDs.
- 24,300 lumens.
- Not compatible with Full Windshield, Flip Windshield and Can-Am Intrusion Bar.
- See table for mounting location and installation.

**Maverick X3, Maverick X3 MAX**

715004007

**24,300 LUMENS**

Lights up to more than 2900 ft (900 m) in front of the vehicle and around 115 ft (35 m) wide on each side.

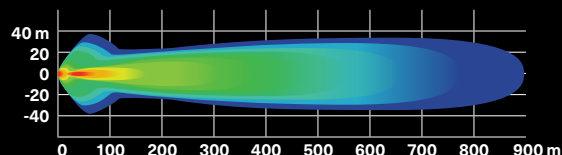

### 15" [38 CM] DOUBLE STACKED LED LIGHT BAR [90 WATTS]

- Equipped with 18 5W Cree LEDs.
- 8,400 lumens.
- Rugged and waterproof.
- EC compliant.
- See table for installation location.

**Maverick X3, Maverick X3 MAX**

715002934



**8,400 LUMENS**

Lights up to more than 1900 ft (580 m) in front of the vehicle and around 65 ft (20 m) wide on each side.

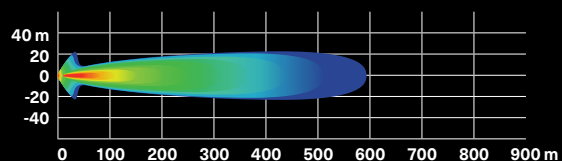

### 10" [25 CM] DOUBLE STACKED LED LIGHT BAR [60 WATTS]

- Equipped with 12 5W Cree LEDs.
- 5,400 lumens.
- Rugged and waterproof.
- Packs a big punch for its size.
- EC compliant.
- See table for installation location.

**Maverick X3, Maverick X3 MAX**

715002933



**5,400 LUMENS**

Lights up to more than 1500 ft (460 m) in front of the vehicle and around 65 ft (20 m) wide on each side.

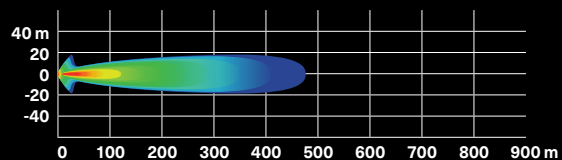

### 4" [10 CM] ROUND LED LIGHTS [2 X 25 WATTS]

- 25W LED spotlights.
- 1,800 lumens.
- Rugged and waterproof.
- Includes basic wiring and switch.
- Can-Am branded grill.
- Sold in pairs.
- Not EC compliant.
- See table for installation location.

**Maverick X3, Maverick X3 MAX**

715002935



**1,800 LUMENS**

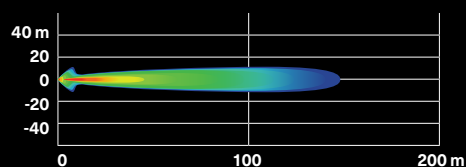

**BUILD YOUR LIGHTING SYSTEM. REFER TO PAGE 46**

Some products shown may not be available or homologated in your country. Contact your BRP dealer for local details.



**FOCUSED & POWERFUL  
LED DRIVING AND  
FLOOD LIGHTS FOR  
TOTAL CONFIDENCE  
AT ANY TIME**

**New 3.5" (9 CM) LED LIGHTS (2 X 14W)**

- 14W LED lights producing 1,260 lumens each.
- Equipped with 6 high power LEDs in a heavy-duty die cast aluminum housing.
- Features 2 attachment points — if one attachment point fails due to a collision, rotate to the next channel point and re-mount the light.
- Sold in pairs.
- EC compliant.

**Maverick X3, Maverick X3 MAX**

**LED DRIVING LIGHTS**

- Spot lens for a narrow and long light beam spread, ideal when driving at higher speeds.

715003666



**LED FLOOD LIGHTS**

- Flood lens for a wide light beam spread, ideal for working applications like plowing or for cornering, dusty or foggy riding conditions.

715003665

**1,260 LUMENS**

**LED DRIVING LIGHTS**

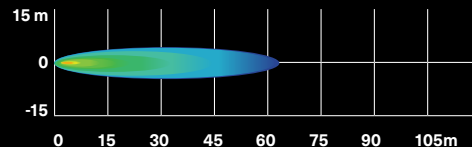

**LED FLOOD LIGHTS**

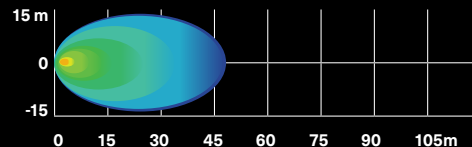

**DOME LIGHT**

- LED array integrates perfectly with vehicle.
- Wiring included.
- Can be installed on cage or roof, with or without roof liner.

**Maverick X3, Maverick X3 MAX**

715002455





# BUILD YOUR LIGHTING SYSTEM IN 3 EASY STEPS

1 CHOOSE YOUR MOUNT POINT	2 CHOOSE YOUR LIGHTS									
	BAJA DESIGNS LIGHTS					CAN-AM LIGHTS				
	10" [25 CM] LED LIGHT BAR	40" [102 CM] ARC LED LIGHT BAR ONX6	XL SPORT LED LIGHTS [SOLD IN PAIRS]	SQUADRON SPORT LED LIGHTS [SOLD IN PAIRS]	XL80 LED LIGHTS [SOLD IN PAIRS]	10" [25 CM] DOUBLE STACKED LED BAR	15" [38 CM] DOUBLE STACKED LED BAR	39" [99 CM] DOUBLE STACKED LED BAR	4" [10 CM] ROUND LED LIGHTS [SOLD IN PAIRS]	3.5" [9 CM] LED DRIVING LIGHTS OR FLOOD LED LIGHTS [SOLD IN PAIRS]
	Consult p.41-42 for more information on these lights.					Consult p.43-45 for more information on these lights.				
FRONT PRE-RUNNER OR DUNE BUMPERS	710006819 PLUS 715002885 (Power Cable)	NA	710006821 PLUS 715002884 (Power Cable)	710004648 PLUS 715002884 (Power Cable)	710005041 PLUS 715003729 (Power Cable)	715002933 PLUS 715003417 (Power Cable)	715002934 PLUS 715003417 (Power Cable)		715002935 PLUS 715003417 (Power Cable)	715003666 or 715003665 PLUS 715003417 (Power Cable)
LONESTAR RACING FRONT BUMPER	NA	NA	710006821 PLUS 715002884 (Power Cable)	710004648 PLUS 715002884 (Power Cable)	710005041 PLUS 715003729 (Power Cable)				715002935 PLUS 715003417 (Power Cable)	715003666 or 715003665 PLUS 715003417 (Power Cable)
LONESTAR RACING FRONT BUMPER AND X RC & X MR FRONT BUMPER	NA	NA	NA	NA	NA	NA	NA	NA	NA	NA
LIGHT SUPPORT BAR ADVENTURE ROOF RACK	710006819 PLUS 715002885 (Power Cable)	710006818 PLUS 715002885 (Power Cable)	710006821 PLUS 715002884 (Power Cable)	710004648 PLUS 715002884 (Power Cable)	710005041 PLUS 715003729 (Power Cable)	715002933 PLUS 715003417 (Power Cable)	715002934 PLUS 715003417 (Power Cable)	715004007 PLUS 715003141 (Light Mounting Kit)	715002935 PLUS 715003417 (Power Cable)	715003666 or 715003665 PLUS 715003417 (Power Cable)
LONESTAR RACING 40" [102 CM] LED LIGHT BAR RACK	NA	710006818 PLUS 715002885 (Power Cable)	NA	NA	NA	NA	NA	NA	NA	NA
LONESTAR RACING LIGHT RACK	NA	NA	710006821 PLUS 715002884 (Power Cable)	NA	710005041 PLUS 715003729 (Power Cable)	NA	NA	NA	NA	NA

## 3 ORDER ORDER ALL PART NUMBERS IN INTERSECTING BOX

\*NOTE: When installing more than one light kit, additional Light Power Cable or Mounting Kit is required.

\*All lights are intended for Off-Road use only.

### BAJA DESIGNS LIGHT POWER CABLE

(Not illustrated)

• Required for installation of Baja Designs LED lights onto roof or bumper.

**Maverick X3, Maverick X3 MAX**

715002885 • 10" (25 cm) Baja Designs OnX6 LED Bars

715002884 • Baja Designs XL Sport LED Lights & Baja Designs Squadron Sport LED Lights

715003729 • Baja Designs XL80 LED Lights



# AUDIO & COMMUNICATION SYSTEMS

Your ride, your trail, your tunes: Pump up the volume wherever you may roam with these ruggedly-engineered audio accessories!



**FIT & COMPATIBILITY**



**QUALITY & RELIABILITY**



**STYLE & VISION**



**NEW**

## AUDIO ROOF

Part punchy stereo, part roof—upgrade your Maverick X3 instantly with a single plug.

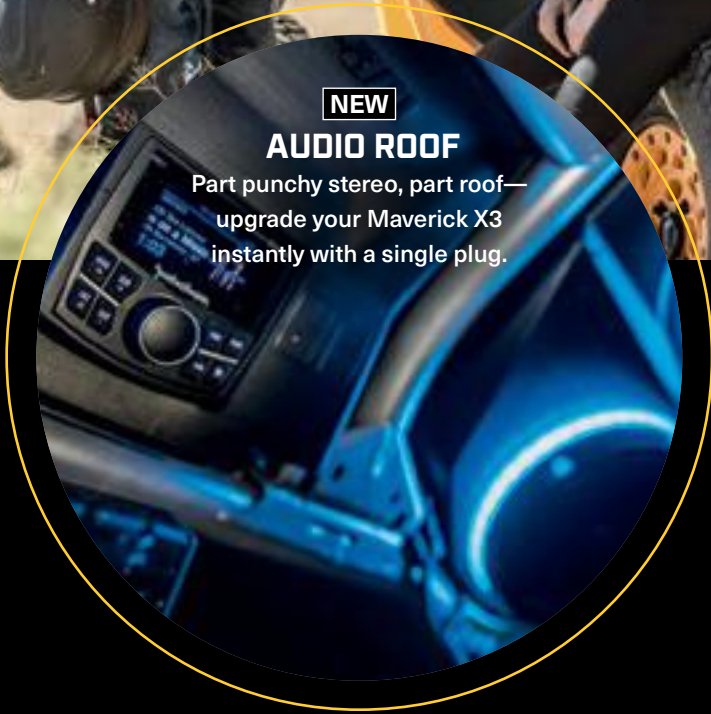

**100%  
integrated**

From the power system to speaker mounting, fit and finish, these audio systems were born to rock your Maverick X3.

**NEW**

## ELECTRONIC DEVICE HOLDER

Adjustable, secure mount to take your smartphone, tablet, or electronic device along for the ride!





### **New** AUDIO ROOF

- Full roof with sleek, built-in audio.
- Fully sealed and waterproof.
- Easy to install: One wire connects the roof to the vehicle's electronics.
- Four 8" speakers, one 400 RMS and 800 Peak Watt amplifier, and one Head Unit supplied by Rockford Fosgate Audio.
- Multi-coloured RGB LED accent lighting around each speaker.
- 2.7" Colour Display with Bluetooth and Pandora connectivity.

**Maverick X3**  
715004900



Our newest approach to audio, with heart-pounding bass, Bluetooth capability, sleek integrated RGB LED lighting—mounted far above mud and other trail debris. Elevate your sound.

### COMPLETE MTX AUDIO SYSTEM

- Bluetooth 5<sup>1</sup> equipped 400W RMS / 800W peak audio system by MTX.
- Designed to be Can-Am-tough in the most demanding riding conditions.
- Includes front-dashboard and rear-roll-cage mounted stereo speakers and head unit with an integrated 6.5" (16.5 cm) subwoofer.
- Add the Electronic Device Holder to securely hold your Bluetooth device ready to play your favorite tunes.

**Maverick X3, Maverick X3 MAX**  
715002873



### MTX CENTRAL SPEAKERS

- Top mounted central speaker case holding two 6.5" (16.5 cm) / 100W speakers.
- Designed to be Can-Am-tough in the most demanding riding conditions.
- Perfect add-on to the Complete MTX Audio System for a 7-speaker system or as a stand alone system by plugging the AUX input jack directly into your music device.
- Not compatible with LoneStar roofs.

**Maverick X3 MAX**  
715004748





## HEART-POUNGING SOUND PERFORMANCE TO MATCH YOUR MAVERICK X3

### RUGGED RADIOS CAR-TO-CAR SYSTEM

- Perfect for communicating with friends and family on group rides.
- Push-to-talk button conveniently mounted on the steering wheel.
- Includes radio mounting bracket, helmet speaker, mic kit and base charger.
- May be synched with the Rugged Radios Intercom System (715002891).
- 2-4 mile range.

#### This kit includes:

- RH-5R Rugged Radios 5-Watt Dual Band Handheld Radio
- Helmet Speaker/Mic Kit
- Push-to-talk buttons
- Mounting bracket
- Base station charger

**Maverick X3, Maverick X3 MAX**  
715003440



### ELECTRONIC DEVICE HOLDER

- A great in-ride entertainment system platform.
- Robust injected-polypropylene construction allows for right fit and easy installation.
- Adjustable unit safely holds most tablets and smartphones measuring between 5.1" (13 cm) and 10" (25.4 cm) (with protective case).
- Combines seamlessly with Complete MTX Audio System and Rugged Radios Intercom System.
- Allows the installation of Garmin Montana 680T GPS.
- Integrated storage (1 Gal (3.8L) capacity) with access to the dash 12V outlet for device charging.

**Maverick X3, Maverick X3 MAX**  
715002874



Integrated storage with access to the 12V outlet for device charging

**EXPERT  
CHOICE**

Take the guesswork out of mounting your devices with a secure, adjustable mount for tablets, smartphones, and electronics

### RUGGED RADIOS INTERCOM SYSTEM

- Specifically designed to facilitate clear in-vehicle communication between driver and passenger(s).
- Expandable to 4 people.
- Includes music port for enjoying your favorite tunes.
- Seamless integration with in-dash switch panel.
- May be synched with the Rugged Radios Car-To-Car System (715003440).

**Maverick X3,  
Maverick X3 MAX**  
715002891



### RUGGED RADIOS HELMET HEADSET KIT FOR REAR PASSENGERS

- Additional 12' (3.7 m) cables and Helmet Speaker/Mic Kits to upgrade your 2-person intercom system into a 4-person system.

**With Rugged Radios Intercom System**  
715004380



**New REAR MIRROR & CAMERA MONITOR**

- Fully waterproof rearview camera and monitor kit.
- Multiple camera feeds can be seen with the rear view camera, to see what you need.
- Unit replaces stock rearview mirror (screen is integrated in the unit's replacement rearview mirror).
- Camera uses infrared light for night vision capabilities.

**Maverick X3, Maverick X3 MAX**

715004905 • Black



Replace your rearview mirror with an integrated daytime / infrared night vision rear camera to follow all the action & friends behind you.

**New AUXILIARY BATTERY INSTALLATION KIT**

(Not illustrated)

- Allows you to add a second 18Ah battery for a dual battery setup necessary to power auxiliary electrical components such as sound systems or winches.
- Equipped with an IP67-rated waterproof electronic module that will prevent your auxiliary electrical components from draining your starting battery.
- Kit includes an additional battery junction block, all necessary wiring and the battery holder.
- Both batteries are perfectly integrated, in stock location, behind the passenger seat.
- Additional battery (410301203), plus battery hardware (250000282) sold separately.

**Maverick X3, Maverick X3 MAX**

715006315

**JUMP STARTER**

- IPX3 water-resistant and enclosed output ports.
- 4 LED battery indicators for easy read on battery charge level.
- Compact design, will conveniently fit in your backpack, glove box or any other storage compartment.
- 2.4A + 1A/5V USB ports for fast charging of all USB devices.
- Smart cable provides protection against reverse polarity, short circuit, low voltage, high temperature and reverse charging.
- Built-in LED light (3 modes).
- Content: 300CA jump starter, SA858 smart cable clamp, MC-USB to USB charging cable, travel bag, user manual.

715005062

**LIGHTED WHIP FLAG**

- A must for riding the dunes.
- 5W Cree LED.
- 5 colored lenses to allow personalization.
- Glow-through whip, quickly-removable and replaceable pole.
- Increases vehicle's visibility.
- Meets most dune-area requirements.
- Die cast aluminum base, acetel hand nut.
- Includes mounting brackets and wiring.
- 4' (1.2 m) flag mounts on top of the roll cage.
- Can be installed on both sides of a vehicle.

**Maverick X3, Maverick X3 MAX**

715002886

**GARMIN MONTANA® 680T GPS**

- Rugged and waterproof, the Montana 680T is element-proof.
- 4" dual-orientation, sunlight-readable touchscreen and glove-friendly touchscreen display, to give you vivid colors and high-resolution images.
- 8-megapixel autofocus camera automatically geotags photos.
- Tracks both GPS and GLONASS satellites for improved positioning and typically faster fixes.
- Preloaded TOPO maps, plus 1-year BirdsEye Satellite Imagery subscription.
- 3-axis compass with barometric altimeter.
- Electronic device holder (715002874) is required for installation.
- Includes a preloaded map for US.

**Maverick X3, Maverick X3 MAX**

715002830



**HEATED VISOR OUTLET**

- Strategically positioned on vehicle to maintain your agility.
- Optional visor outlet that delivers fog-free riding.
- Quick and easy installation.
- Sold individually.
- Heated Visor not included.

**Maverick X3, Maverick X3 MAX****715001246****USB POWER OUTLET KIT**

- Recharges your electronic devices while riding\* (smartphone, MP3, heating gear, etc.).
- Dual port USB connectors.
- \*The power outlet is not capable of recharging all device types while riding.

**Maverick X3, Maverick X3 MAX****219400510****HEATED ACCESSORIES WIRING HARNESS**

(Not illustrated)

- Electric harness required to hook up and operate front heated seats, heated steering wheel and grab bar.

**Maverick X3,****Maverick X3 MAX****710005757****HEATED SEAT**

- 30W seat heater delivers chill-free riding comfort.
- Hi/Low temperature settings allow you to control the desired degree of warmth.
- This kit includes one carbon fiber seat heater, foam sheet and in-dash switch.

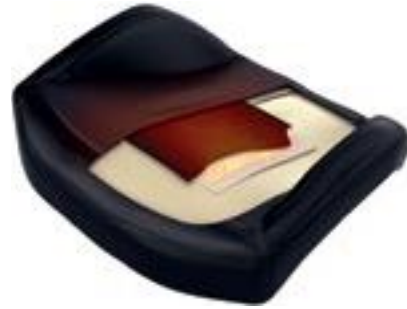
**Maverick X3,****Maverick X3 MAX****715005112****CGX3 CAMERA**

- 160° wide angle lens.
- Resolution options: From 3MP up to 20MP and VGA.
- Video resolutions available: 2.7K at 30 frames per second (FPS), 720P at 120/60/30 FPS, 1080P at 60/30 FPS and VGA at 240 FPS.
- Record videos in 4K UHD at 24 FPS, 2.7K QHD at 30 FPS and 720P at 120 FPS.
- Memory: Class 10 32GB Micro SD card.
- 2" (5 cm) capacitive touchscreen.
- Li-ion battery capacity of 1050mAh, working time of 1/1.5 hours and charging time of 3 hours (2 batteries included).
- WiFi function remotely operates up to 10-15 meters with mobile devices and Cyclops app for Android and iOS.
- Waterproof up to 10 meters without a case.
- Features modes such as invert, time lapse, high speed and loop recording, motion detection, capture (while recording a video), burst and anti-sharing.
- Comes with 8 mounting accessories.

**9700130090****CGX3 GIMBAL CAMERA STABILIZER**

(Not illustrated)

- 3-axis full 360-degrees precision: Eliminates shaky video and allows you to easily shoot pro-quality, cinematic-like footage with your Action Camera.
- Independent APP to control the gimbal.
- Built-in Bluetooth 4.0.
- Compatible with iOS 8.0 and Android 4.4 or above.
- Rechargeable battery.
- Rugged, full aluminum alloy.
- 5-way joystick and multi-function button for flexible operations and convenient switch.

**9700160090****CGX3 LED LIGHT**

(Not illustrated)

- Wide-Angle 300 Lumen Max. (5500K-6000K) by 3 LEDs.
- Waterproof, attachable light
- Three modes of light: High, Low, Flashing.
- Rechargeable battery: 1050mAh.

**9700200090****CGX3 POWER STICK MOUNT**

(Not illustrated)

- 5200mAh of continuous power in your hand, when you need it.
- Rubberized silicone handle for comfort and grip.
- Power indicator light to let the user know when the battery is running low.
- Includes power hand grip, long screw, convert tripod mount, phone clip mount, USB mini cord, USB micro cord and adjustable strap.

**9700100090****CGX3 SELFIE STICK**

(Not illustrated)

- Easily take photos or record videos with the CGX3 Selfie Stick.
- This selfie stick is made tough for any sport or activity.

**9700170090**



## WARN<sup>†</sup> VRX

- Extreme IP68-rated waterproof sealing keeps the elements out.
- Durable all-metal construction.
- Black powder-coated finish and stainless steel fasteners for corrosion resistance.
- Robust new clutch design based on 70+ years of WARN 4WD hub lock know-how.
- Load-holding brake for great control.
- Smooth and reliable all-metal three-stage planetary gear train.
- Dash-mounted rocker control and corded remote.
- Limited lifetime warranty (mechanical), 3-year warranty (electrical).
- Pulling strength capability of 4,500 lb (2,041 kg).

### **New** WARN VRX 45 WINCH

- 50 ft. of 1/4" (15 m of 6.3 mm) wire steel cable.
- Roller fairlead.
- Winch Electrical Harness (715003585) and Front Pre-Runner Bumper or X mr/X rc Front Bumper are required for installation.

**Maverick X3, Maverick X3 MAX**

715006110



### **New** WARN VRX 45-S WINCH

- 50 ft. of 1/4" (15 m of 6.3 mm) synthetic rope.
- Cast aluminum fairlead.
- Winch Electrical Harness (715003585) and Front Pre-Runner Bumper or X mr/X rc Front Bumper are required for installation.

**Maverick X3, Maverick X3 MAX**

715006111



## CAN-AM HD

- Ergonomic clutch handle.
- Rugged all-steel gears and bushings for more torque and durability.
- Automatic 100% load-holding brake.
- Sealed solenoid for all-weather protection.
- Weather sealed corded remote and dash mounted switch.
- EC compliant.

### CAN-AM HD 4500

- Pulling strength capability of 4,500 lb (2,041 kg).
- 43' of 15/64" (13.1 m of 6.3 mm) wire steel cable.
- Heavy-duty 4-way roller fairlead.
- Winch Electrical Harness (715003585) and a Front Pre-Runner Bumper or X mr/X rc Front Bumper are required for installation.

**Maverick X3, Maverick X3 MAX**

715006416



### CAN-AM HD 4500-S

- Pulling strength capability of 4,500 lb (2,041kg).
- 50' of 1/4" (15.2 m of 6.35 mm) wire synthetic cable.
- Corrosion-proof aluminum hawse fairlead.
- Winch Electrical Harness (715003585) and Front Pre-Runner Bumper are required for installation.

**Maverick X3, Maverick X3 MAX**

715006417



**CAN-AM HD HAWSE FAIRLEAD**

- A must when upgrading your winch with a synthetic cable, this corrosion-proof aluminum hawse fairlead will prevent the cable from snapping in a corner of a roller fairlead and from wearing prematurely due to the rough surface of the worn roller guide.
- Must be used with synthetic cables only.

**Can-Am HD winch**

715006426

**WARN HAWSE FAIRLEAD**

- Double-powder-coated construction.
- Required to use the Synthetic Winch Cable (705015070) on Warn winches.
- To be used with synthetic winch cables only.

705208797

**ROLLER FAIRLEAD**

- Suggested when changing the wire rope.
- Heavy-duty replacement fairlead for winches.

**With Warn winch**

715001119

**With Can-Am HD winch**

710007082

**WARN WIRED REMOTE CONTROL**

- This kit allows winch owners to add the hand-held remote to their stock winch.
- EC compliant.
- Harness (710001023) is required to use remote control on a vehicle with a factory installed winch.

**With Warn winch**

710001002

**CAN-AM HD WIRED REMOTE CONTROL**

- This kit allows winch owners to add the hand-held remote to vehicles with their stock winch.
- EC compliant.
- Remote control (715007050) and connection socket are included.

**With Can-Am HD winch**

715006504

**WIRELESS REMOTE CONTROL**

- The system is quick and easy to install, thanks to a wiring harness with an integrated antenna and all necessary mounting hardware.
- Allows you to operate your winch from anywhere within a 50' (15.2 m) radius, increasing your recovery options.
- All components are weatherproof.

**With Warn winch**

715002542

**WINCH ELECTRICAL HARNESS**

(Not illustrated)

- Required for winch installation.

**Maverick X3, Maverick X3 MAX**

715003585

**SYNTHETIC WINCH CABLE**

- 50' of 1/4" (15.2 m of 6.35 mm) synthetic cable for Warn winch.
- Warn Hawse Fairlead (705208797) is required when upgrading to a synthetic cable to avoid damage and premature wear of the cable.

**With Warn winch**

705015070

- 50 ft. of 3/16" (15.2 m of 4.8 mm) synthetic cable for winches.
- Hawse Fairlead (715006426) required when upgrading to a synthetic cable to avoid premature cable damage and wear.

**With Can-Am HD winch**

715006430

See your dealer or visit [can-amoffroad.com](http://can-amoffroad.com) for the price.**WIRE ROPE REPLACEMENT**

- 55' of 1/4" (16.8 m of 6.35 mm) wire rope for Warn winch kit.

**With Warn winch**

715006699

- 43' of 15/64" (14.3 m of 6.3 mm) wire rope.
- 4,500 lb (2,041 kg) pulling strength.

**With Can-Am HD winch**

705014978

**SYNTHETIC CABLE EXTENSION**

- Lightweight 1/4" (6.3 mm) diameter, easy to handle and won't rattle in cargo box.
- Easily attaches to winch cable to provide additional 50' (15.2 m) of distance.
- 4,500 lb (2,041 kg) single line capacity.

715001120

**X RC / X MR REAR TOW HOOK**

- Offers a solid place to hook onto in case towing is needed.
- Allows you to attach most straps and hooks.
- Made of rugged 3/16" (5 mm) steel plate and 5/8" (16 mm) steel hook tube.
- Standard on Maverick X rc and X mr models.

**Maverick X3, Maverick X3 MAX**

715004450

**REAR HITCH**

- Rugged lightweight steel construction.
- E-coated finish.
- Fixed mounting point for trailer ball to provide vehicle with towing capabilities.
- This hitch offers 1,500 lb (590 kg) of towing capacity.
- Hitch ball not included.

**Maverick X3, Maverick X3 MAX**

■ 715002883 • Black

■ 715003938 • Can-Am Red





# GRIP LIKE NEVER BEFORE

**Can-Am exclusive: Respond to off-road conditions like never before with 4WD powered by Smart-Lok Technology.**

Smart-Lok is the most advanced off-road differential at your command. It's a fully lockable on-the-fly front differential with electronically-controlled automatic modes that always returns maximum traction in every condition, period.

## 1 START WITH THE SMART-LOK DIFFERENTIAL

### SMART-LOK™ DIFFERENTIAL

- Can-Am-exclusive Smart-Lok™ technology constitutes a true full lockable on-the-fly front differential with electronically-controlled automatic modes.
- Choose your differential settings according to your riding need: "2x4" for rear wheel traction only, "4x4 Front Diff Lock" for a fully locked 4 wheel drive, and "4x4 Smart Modes" that offer preset, intelligent calibrations for your type of riding.
- Using multiple input sources, "Smart Modes" will instantaneously engage locking with the right load at the right moment to procure maximum traction while retaining low-speed maneuverability, allowing for optimal placement and a feeling of confidence.
- The Smart-Lok Kit comes standard with the Trail Mode.
- Mud, Rock and Trail Activ modes can be added by installing an additional Smart Mode Module (sold separately) to fine-tune your riding environment.
- Requires Performance Half Shafts (2x) and Front Differential Kit for installation.

**Maverick X3 produced after January 1st, 2017, Maverick X3 MAX**

**705402371**

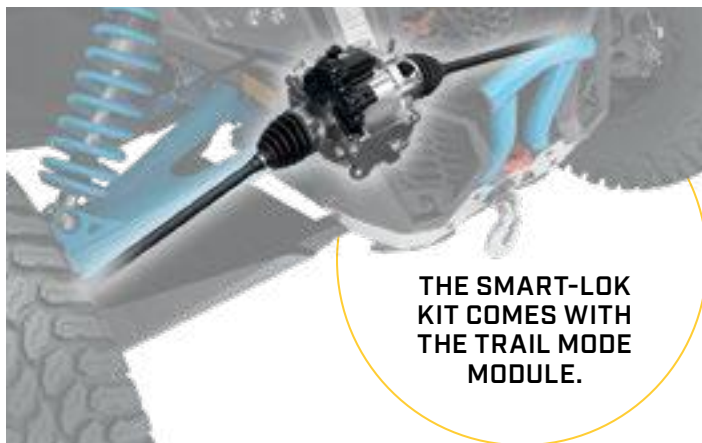

**THE SMART-LOK KIT COMES WITH THE TRAIL MODE MODULE.**



## 2 GET THE SMART-LOK INSTALLATION KIT & PERFORMANCE HALF SHAFT

Both are required to install the Smart-Lok™ Differential Kit.

### SMART-LOK™ INSTALLATION KIT

(Not illustrated)

- Includes all necessary hardware and wiring for Smart-Lok Differential installation.

**Maverick X3 produced after January 1st, 2017, Maverick X3 MAX 2018 and prior**

**715004746**

**Maverick X3, Maverick X3 MAX 2019 & up**

**715005329**



### PERFORMANCE HALF SHAFT

- High-performance design ideal for off-road use, with superior wheel power and acceleration for racing, dunes and desert riding.
- Includes CVs, Shaft and Boots with the best suited geometry for your Can-Am vehicle.

**Maverick X3, Maverick X3 MAX (64" models)**

**705401634**

**Maverick X3, Maverick X3 MAX (72" models)**

**705402048**







### 3 FINE-TUNE YOUR RIDING ENVIRONMENT WITH A SMART MODE MODULE (OPTIONAL)

These modules allow you to add the **Mud, Rock or Trail Activ** Smart Mode to vehicles equipped with the Smart-Lok™ Differential Kit. Only one Smart Mode Module can be installed at a time.

#### POWER THROUGH DEEP MUD

- Designed to deliver superior traction in the deepest mud holes.
- When high engine torque and/or slippage is detected, Smart-Lok™ will fully lock the front end.
- The system will stay locked until throttle release.

#### MUD SMART MODE MODULE

Models with Smart-Lok™ Differential  
715005282

#### DRIVE WHERE IT ROCKS

- Designed to help cross challenging rocks.
- When high engine torque is detected at low vehicle speed, Smart-Lok™ will progressively lock the front end and will stay engaged until throttle release to prevent wheel slippage and provide optimal traction.
- The progressive engagement allows for easier steering when maneuvering the vehicle.

#### ROCK SMART MODE MODULE

Models with Smart-Lok™ Differential  
715005283

#### LET THEM TRAIL BEHIND

- Designed for aggressive riding delivering the ultimate cornering precision.
- When high engine torque and/or an increase in vehicle speed is detected, Smart-Lok will progressively engage the front end and maintain it engaged until throttle release or vehicle speed reduction.
- The progressive engagement allows for lower smooth steering effort.

#### TRAIL ACTIV SMART MODE MODULE

Models with Smart-Lok™ Differential  
715005284



**LONESTAR RACING HEAVY-DUTY SHIFT PLATE & KNOB**

- The shift plate is made from durable stainless steel and bolts into place for a secure fit.
- The kit comes with a billet aluminum Lonestar Racing shift knob.
- Offers improved durability for the performance oriented driver.

**Maverick X3, Maverick X3 MAX**  
715004866

**LONESTAR RACING MUD FLAPS WITH BRACKETS**

- These bolt-on mud flaps make a great addition.
- Durable chromoly brackets.
- Protect trailing arms, rotors and CVs from rocks and debris.
- Sold in pairs.

**Maverick X3, Maverick X3 MAX**  
715004865

**LONESTAR RACING OUTER TOE LINK BOXED GUSSETS**

- Protect and strengthen the middle radius rod links from rough riding conditions.
- Include high-grade steel bolts.

**Maverick X3, Maverick X3 MAX**  
715004868



Some products shown may not be available or homologated in your country. Contact your BRP dealer for local details.



GET THE PERFORMANCE  
YOU CRAVE WITH  
UPGRADES WORTHY  
OF OUR RACERS

### LONESTAR RACING QUICK RELEASE CLUTCH COVER PINS

- This kit will allow you to take off your clutch cover in seconds to access the belt tool-lessly.
- Includes 4 stainless steel "quick-release" pins with clips and tethers.
- Replaces all clutch cover screws.
- This product affects the clutch cover sealing. It is highly recommended to use this product under dry riding conditions only.

**Maverick X3, Maverick X3 MAX**

715005045

### LONESTAR RACING HEAVY-DUTY REAR BOXED ROD SUPPORT PLATE

- Double-layered radius rod support plate made of high-grade steel.
- Reinforces your rod mounting location on the frame while adding a mean racing look to your vehicle.
- Easy to install.

**Maverick X3, Maverick X3 MAX**

715005046

### LONESTAR RACING FIRE EXTINGUISHER SUPPORT

- Quick-release support that allows you to slide the fire extinguisher out in a matter of seconds in an emergency situation.
- Made of billet anodized black aluminum.
- Provides you with the safety and security of having dependable emergency equipment on board.
- Fits 1.85" (4.7 cm) tubing.
- Can be fixed everywhere on the cage.
- Comes with both billet mounts, quick-pull pin, mounting plate and 2 clamps.
- Fire extinguisher sold separately.
- "LoneStar Racing for Can-Am" branded.

**Maverick X3, Maverick X3 MAX**

715003734





**New YOSHIMURA SLIP-ON EXHAUST**

- Developed in collaboration with Yoshimura.
- Made from 304-grade stainless steel with brushed aluminum tip.

**Maverick X3, Maverick X3 MAX**

715005183 • In-Line Triple

715002882

- Better sounding, better looking and 19% lighter than stock muffler.
- USDF/USDA approved spark arrester.

- Fuel injection system tuning not required.
- ROHVA and EPA compliant.
- Not EC compliant.



New full exhaust upgrade for adding legendary Yoshimura sound to your Maverick X3 build.

## FOX® HIGH-PERFORMANCE 2.5 / 3 BYPASS SHOCK KIT\*

- Front piggyback and rear remote reservoir shock upgrade kit, gives you the same suspension performance as X rs models.
- Improved ride comfort and vehicle handling.
- Internal Bypass Technology offers position-sensitive damping designed to adapt to any terrain and provide extra plush.
- Dual Speed Compression (DSC) adjusters.
- High level of adjustments and controls, allowing enthusiasts of all skill levels and driving styles to fine-tune their ride for any terrain or conditions.
- Wide-range rebound adjustment.
- Dual rate springs with adjustable crossover and preload.
- Direct replacement bolt-on shocks.
- 29" tire recommended.

**Maverick X3 (except X rs models)**

715003937



## OFF-ROAD SCREW JACK

- Race-inspired screw-type design for lifting your vehicle and changing flats fast and effortlessly while on the trail.
- Can be easily operated with any standard socket wrench or impact gun (1/2" (13 mm) drive).
- Integrated support base to facilitate mounting on spare tire carriers.
- Features two fixed attachment points for secure lift spot.
- Height can be adjusted between 7.5" (19 cm) and 42.5" (108 cm).

**Maverick X3, Maverick X3 MAX**

715006190

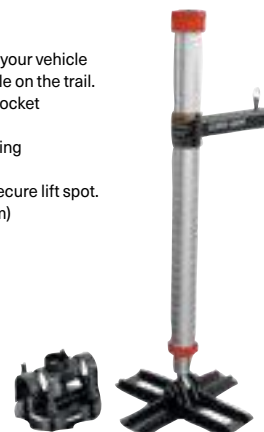

## **New** X RC BRAKE PEDAL

- Brake pedal with larger foot surface.
- This improves ergonomics and control for the rider in rock climbing conditions.

**Maverick X3, Maverick X3 MAX**

715004901



## HIGH OUTPUT 172HP UPGRADE KIT X3

- Performance upgrade kit for Maverick X3 2017 models only.
- Gain 18 HP for a total of 172 HP.
- Includes: Intercooler with fan, fuel pump catalyst and high performance belt.
- Installation must be done by an authorized BRP dealership to preserve the vehicle's warranty.
- C.A.R.B. Executive Order #D-799U.

**Maverick X3, Maverick X3 MAX (2017 models)**

715004700



## ARCHED LOWER SUSPENSION LINKS

- Arched lower links to free up more ground clearance.
- Standard on X mr and X rc models.

**Maverick X3, Maverick X3 MAX**

715005066 • 72" models

715005065 • 64" models

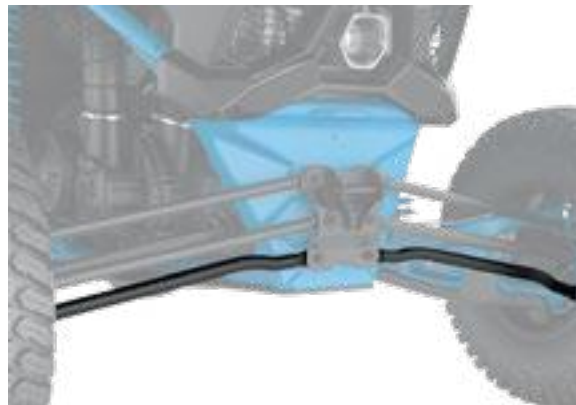

\*WARNING: Any modifications or addition of accessories may affect the handling of your vehicle. It is important to take the time to get familiar with the vehicle once modifications are made to understand how to adapt your driving behavior accordingly. Do not tamper with unauthorized modifications or install equipment not specifically certified by BRP for the vehicle. These modifications have not been tested by BRP and they may increase the risk of injury or loss of control, or render the vehicle illegal to ride. Ask your authorized BRP dealer for suitable available accessories for your vehicle.

## MUD-TESTED UPGRADES FOR PLAYING IN THE DEEP

### **New** RADIATOR RELOCATOR

- Relocates radiator to rear of cage.
- Protects it from debris and rocks.
- Prevents cooling performance loss in muddy condition.
- Reduces hot air in the cabin.
- Easy to clean.
- Includes support hardware and hoses.
- Not compatible with any bed accessories, Rear Cage mounted accessories, Complete MTX Audio system & Upper Soft Doors.

**Maverick X3, Maverick X3 MAX**

715004937



### **New** SNORKEL PRE-FILTER

- Pre-filter specifically for snorkels.
- Adds extra protection to your engine in harsh riding conditions.
- Helps keep air filter cleaner.
- Filter blocks particles larger than 0.005" (0.13 mm).
- Necessary to maintain vehicle warranty when tracks are installed.

**Maverick X3**

715005599



### S&B PARTICLE SEPARATOR

- Uses vortex generators to eject approximately 94% of dust, snow, or silt before it even reaches your airbox.
- Helps maintain power, protect your engine and dramatically extend the life of your filter.
- Adjusts and clamps onto either the upper or lower roll bars, and accommodates installed roofs.
- Not compatible with Rear Intrusion Bars on 2019 models.

**Maverick X3 (except X mr models), Maverick X3 MAX**

715004297



### SNORKEL KIT

- Raises point of engine and CVT air intakes so vehicle can be semi-submersed in water/mud without taking in water to the engine.
- Not compatible with S&B Particle Separator, LinQ Pivoting Rack, Lonestar Racing Rear Intrusion Bar and all rear panels and windows.
- Standard on Maverick X3 X mr models.
- Sealed Air Box (707800780, sold separately) is required for installation on models produced before January 1st, 2018.
- Not EC compliant.

**Maverick X3, Maverick X3 MAX**

715003733



## EMERGENCY KIT

- Complete emergency kit provides all essential equipment and supplies to get out of most unfavorable situations powersport enthusiasts can find themselves in.
- Includes: Jumper Cables, Air Compressor, Tire Repair Kit, First Aid Kit, Ratchet Tie-Down, Duct Tape, Tow Strap 3,300 lb (1,500 kg), Zip-Ties, Cloth Rags.

**Maverick X3, Maverick X3 MAX**

715006102



## PERFORMANCE TWIN AIR FILTER

- The best choice for the harshest conditions.
- Multiple staged oiled filtering foam for superior dust retaining capacity with high air flow.
- Washable and reusable.

**Maverick X3, Maverick X3 MAX**

715002895



## FOAM REPLACEMENT

(Not illustrated)

- Replacement foam for Performance Twin Air Filter.

**Maverick X3, Maverick X3 MAX**

707800713

# COVERS & ADD-ONS



## TRAILERING COVER

(Not illustrated)

- Heavy-duty canvas made of UV-resistant solution-dyed polyester.
- Inner soft liner protects windshield and colored panels from abrasion.
- All high-abrasion areas are reinforced with a double canvas layer.
- Weather-resistant trailering cover protects your vehicle during storage and transportation.
- Opening for fuel cap and cabin access on passenger side.
- Quick and easy installation.
- Designed to perfectly fit your vehicle with or without Can-Am accessories.

**Maverick X3**

715005813

**Maverick X3 MAX**

715005814

## BOLT-ON<sup>1</sup> RETRACTABLE RATCHETING TIE-DOWNS

- Perfect for transporting your powersport vehicle or securing loads.
- Mounts easily: Bolts on any flat surface (e.g. truck bed or frame).
- 1" x 6' (2.5 cm x 1.8 m) tie-down strap with heavy-duty stitching that delivers a 500 lb (226 kg) working load strength and 1,500 lb (680 kg) break strength.
- Convenient retractable push button automatically slackens, spools and stores away strap, while the ratchet mechanism tightens the strap snugly to secure your vehicle or load into place.
- Rubber ratcheting handle provides firm grip, and the hook is vinyl coated to protect whatever surface it hooks into.
- Sold in pairs.

295100737



## RATCHET TIE-DOWNS

- 400 lb (181 kg) safe working load.
- 1" x 10' (2.5 cm x 3 m) strap with Sea-Doo, Ski-Doo and Can-Am logos.
- Deluxe ratchet with rubber handle.
- Coated S hooks.
- Pack of 2.

**860200447**

**Black/Grey**



# APACHE

## TRACK SYSTEMS

Each track has a specific purpose and is designed without compromise for work and play. Whether it's for deep snow riding, trail riding or for heavy loads, Apache tracks are akin to floating across the terrain.



**FIT &  
COMPATIBILITY**



**QUALITY &  
RELIABILITY**



**STYLE &  
VISION**



## APACHE BACKCOUNTRY

Finally explore winter with no traction limitations and no compromise, thanks to the unmatched performance of Apache Backcountry track kits. Engineered to thrive in the deepest snow—for work or play. Don't let winter stand in the way.

**P.63**

## APACHE 360 LT

Adapt your track setup to the conditions you'll be riding in and the purpose of your ride with the Apache 360 LT system: our all-season, all-terrain masterpiece.

**P.64**



## APACHE BACKCOUNTRY

The same technology behind our world-renowned snowmobiles is at your command. With a larger contact patch, and more aggressive track design, travel beyond what you thought possible with the best snow performance.

COVERED BY A 1-YEAR WARRANTY



EFFICIENT FRAME AND RAIL DESIGN ENSURES WEIGHT IS EVENLY DISTRIBUTED

ADDED GROUND CLEARANCE OF 6.4" (16.2 CM)

AGGRESSIVE TRACK DESIGN WITH A 2" (5 CM) LUG HEIGHT FOR MAXIMUM TRACTION

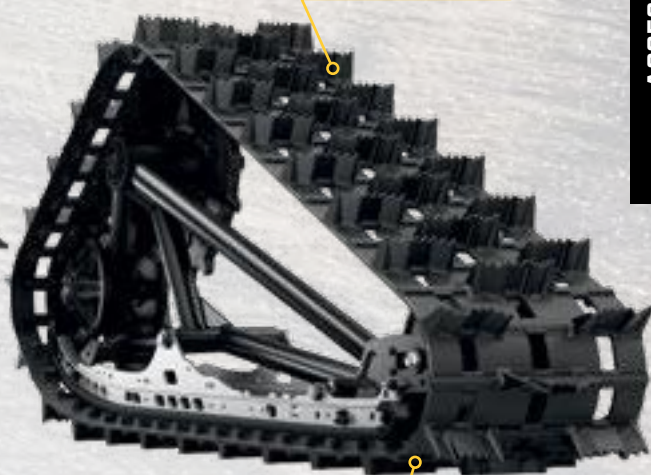
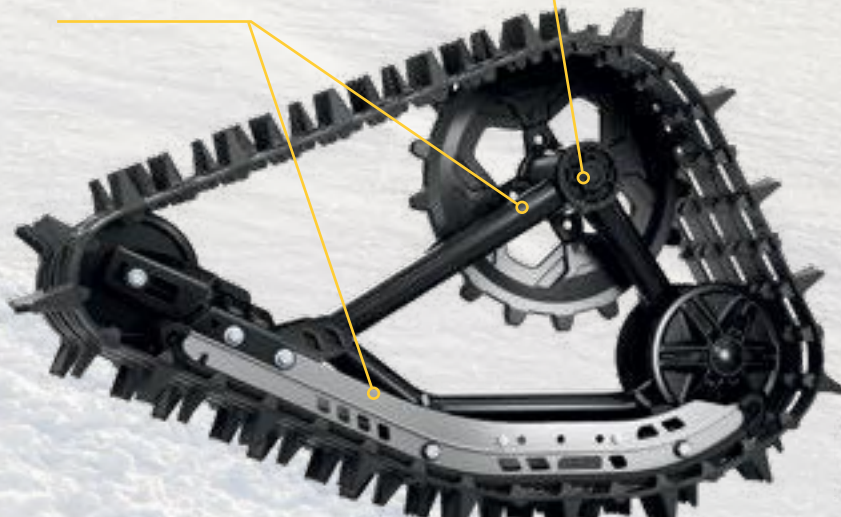

LARGEST CONTACT PATCH ANYWHERE: 37% MORE THAN THE APACHE 360 LT

### New APACHE BACKCOUNTRY LT TRACK SYSTEM

- Tracks designed to deliver the best snow performance on the market with unmatched flotation level and traction on snow surface.
- Large contact patch, 37% bigger than the Apache 360 LT.
- Impressive added ground clearance of 6.4" (16 cm), helps keep the vehicle over the snow.
- Lightweight snowmobile-inspired rail design.

**Maverick X3, Maverick X3 MAX**  
715004734

- Aggressive track design with 2" (5 cm) lug height for maximum traction on snow.
- Apache Backcountry LT Mounting Kit, Track DPS Module and Engine & CVT Pre-Filter are required.
- Fine-tune your track system using extra Idler Wheels, Sliders with Vespel Inserts and Rail Ice Scratcher.
- For winter use only.

### New APACHE BACKCOUNTRY LT MOUNTING KIT

- Required for installation of the Apache Backcountry Track LT System.
- DPS module and Pre-Filter are required and sold separately.

**Maverick X3, Maverick X3 MAX**  
64" models 715004397      72" models 715004394

# APACHE 360 LT

Rise above terrain and weather, with the Apache 360 LT track kits — the upgrade that takes the Can-Am experience to another level. Designed for superior traction and carrying heavier loads in soft terrain, 360LT track kits can be installed on ATV and SSV vehicles and used for exploring and completing tough tasks.

COVERED BY A 2-YEAR WARRANTY

 QUICK & EASY INSTALLATION

ADDED GROUND CLEARANCE OF 4.5" (11.4 CM)

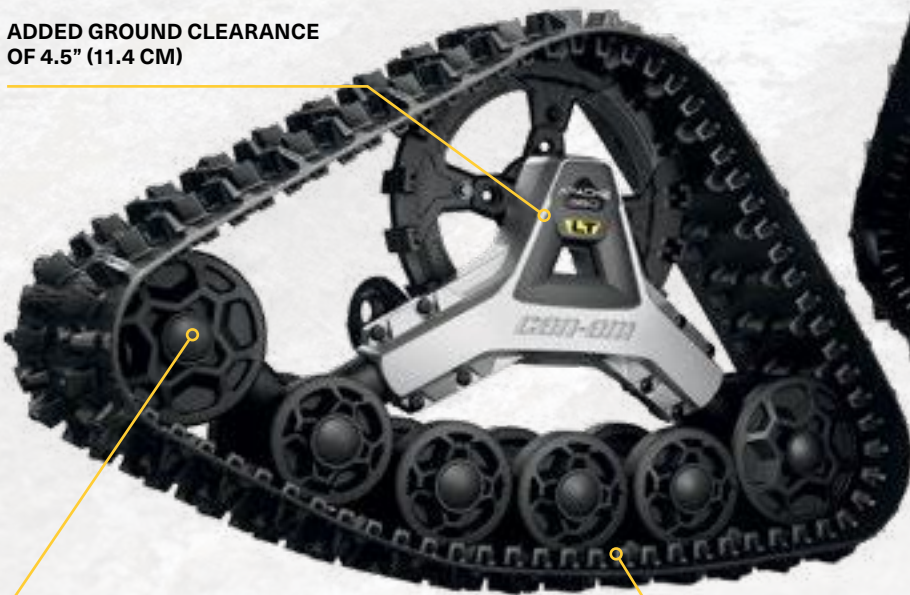

TOTAL GROUND SURFACE AREA OF 2,079.7 IN<sup>2</sup> (13,417 CM<sup>2</sup>)

UNIQUE ADJUSTABLE CONTACT PATCH SYSTEM TO TACKLE THE TOUGHEST CONDITIONS



RUBBER OVER MOLDED HEAVY-DUTY DOUBLE BEARING WHEELS AND OFFSET WHEEL SPACING REDUCE FRICTION AND VIBRATION WHILE ENSURING RELIABILITY

## APACHE 360 LT TRACK SYSTEM

- Multifunctional tracks designed to support heavy loads and to fit on most Can-Am off-road vehicles.
- Front wheel height adjustment provides enhanced attack angle and better performance over rough terrain when raised or increased contact patch for improved flotation when lowered.
- Average ground clearance increase of 4.5" (11.4 cm).
- 1" (2.5 cm) lugs in the front and 1.25" (3.2 cm) in the back.
- Apache 360 LT Mounting Kit, Track DPS Module and Engine & CVT Pre-Filter Kit are required.
- Reliable heavy-duty build.
- EC compliant.
- Recommended for use on snow only for Maverick X3.

**Maverick X3, Maverick X3 MAX**

715005103

## APACHE 360 LT MOUNTING KIT

(Not illustrated)

- Required for installation of the Apache 360 LT Track System.
- Track DPS Module and Pre-Filter not included.

**Maverick X3, Maverick X3 MAX**

**64" models**

715004392

**72" models**

715004393

Required to install the Apache Backcountry and Apache 360 LT Track Systems

## ENGINE & CVT AIR INTAKE PRE-FILTER

- Adds extra protection to your engine in harsh riding conditions.
- Helps keep air filter cleaner.
- Filter blocks particles larger than 0.007" (0.19 mm).
- Easy, tool-less installation.
- Not compatible with S&B Particle Separator.
- Necessary to maintain vehicle warranty when tracks are installed.

**Maverick X3, Maverick X3 MAX**

715005600



## TRACK DPS MODULE

(Not illustrated)

- Innovative DPS module that ensures speedometer accuracy and optimized steering assist, making for perfect track control and riding ease.
- Required to install the Apache Track Systems.

**Maverick X3, Maverick X3 MAX**

715004707

Some products shown may not be available or homologated in your country. Contact your BRP dealer for local details.

# PROMOUNT — PLOWS



**FIT &  
COMPATIBILITY**



**QUALITY &  
RELIABILITY**



**STYLE &  
VISION**

The new ProMount lineup was created for both professional operators and enthusiasts looking to take their tool kit to the next level. Designed to work as efficiently as possible, Can-Am reimaged the plow from mount to blade.

## MOST EFFICIENT MOUNTING SYSTEM

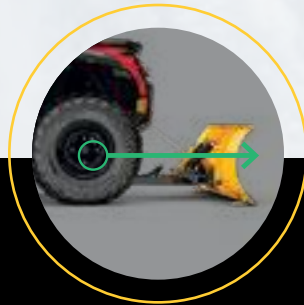

Underbelly mounting plate provides the **optimal angle of attack** for best push strength.

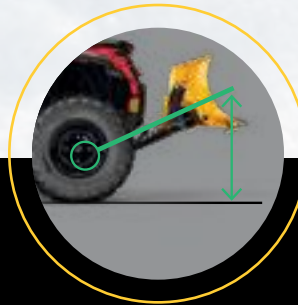

The forward mounted push frame provides **industry leading lift height**.



Low profile mounting plate has **little impact on ground clearance** and can be left installed year round.

## CONNECTS WITH A CLICK

Attachable in **FOUR EASY STEPS**, the Can-Am ProMount plow system is the fastest, easiest way to start plowing and get the job done—minimal effort for maximum result.

**1**

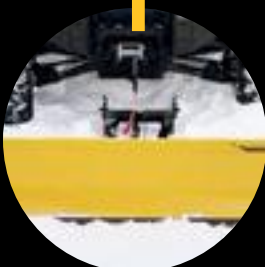

Drive straight toward the plow.

**2**



Attach the winch cable to the plow using a guiding hook/roller.

**3**



Lift the plow until it clips onto the mounting plate.

**4**



Remove the winch cable from the guide. You're ready to plow.

## CAN-AM PROMOUNT STEEL PLOWS

Made from 12-gauge steel and designed for efficient plowing, the ProMount steel blades are offered in multiple sizes.

### CAN-AM PROMOUNT STEEL PLOW KITS

These kits include:

- Can-Am ProMount Steel Blade
- Push Frame with Quick-Attach System
- Mounting Plate (not illustrated)

**Maverick X3, Maverick X3 MAX**

- 715004474 • Black
- 715006303 • Yellow



72" (183 cm)

### CAN-AM PROMOUNT STEEL BLADES

- Blades available individually to create your own kit.
- Compatible with Can-Am ProMount Blade accessories to further enhance plow versatility.

#### 72" (183 CM) BLADE

- Clears 66" (168 cm) when plow is fully angled.
- Blade height of 17" (43 cm).

**ProMount Push Frame**

- 715004474 • Black
- 715006021 • Yellow



72" (183 cm)

# CAN-AM PROMOUNT FLEX2 PLOWS

HMWPE (High Molecular Weight Polyethylene) technology gives Flex2 greater reliability, resistance to impact, and immunity to rust or deformation. Tough on jobs but flexible in the face of obstacles, the Flex2 blade simplifies work.

## CAN-AM PROMOUNT FLEX2 PLOW KIT

### These kits include:

- Can-Am ProMount Flex2 Blade
- Push Frame with Quick-Attach System
- Mounting Plate (not illustrated)

### 72" (183 CM) BLADE

Maverick X3, Maverick X3 MAX

■ 715003910 · Black



72" (183 cm)

## CAN-AM PROMOUNT FLEX2 BLADES

- Blades available individually to create your own kit.
- Compatible with Can-Am ProMount Blade accessories to further enhance plow versatility.

### New 72" (183 CM) BLADE

- Clears 66" (168 cm) when plow is fully angled.

**ProMount Push Frame**

■ 715004485 · Black



72" (183 cm)

**CREATE  
YOUR  
OWN KIT**

by choosing any plow type/length that you'd like for your push frame.

**ProMont Push Frames are compatible with all the blades.**

# YOUR JOB, YOUR CHOICE

Get a custom solution that truly fits the task at hand—with quality components and no cut corners. The ProMount mounting plate, push frame, and blades are a universal system that can be adapted to your specific Can-Am and jobsite.

## CAN-AM PROMOUNT PUSH FRAME WITH QUICK-ATTACH SYSTEM

- Heavy-duty steel tubes designed to withstand the roughest use.
- Mid-mount carriage provides ultimate push strength and traction.
- Designed for maximum plow lift height.
- Features a self-aligning quick-attach system, an easy foot release pedal and an ergonomic handle for plow angle adjustment.
- Plow Roller Fairlead and Plow Limit Switch recommended to extend winch cable lifespan.
- Can-Am ProMount Mounting Plate required for installation.
- Blade swivels left or right, 5 positions.
- Large pin designed for easy blade rotation to eliminate dirt and snow buildup at pivot point.

**Maverick X3, Maverick X3 MAX**

715003910



Compatible with all ProMount plows

## PUSH FRAME EXTENSION

- 12" (30 cm) push frame extension required when plow is installed with Apache Track Systems.

**Maverick X3, Maverick X3 MAX**

715006257



Required when plow is installed with Apache Track systems

## CAN-AM PROMOUNT MOUNTING PLATE

(Not illustrated)

- Required to install the Can-Am ProMount Push Frame with Quick-Attach System.
- Mounting plate precision-designed to stay on year round without compromising ground clearance.
- Fits with or without Can-Am Skid Plates.

**Maverick X3, Maverick X3 MAX**

715004484

# CAN-AM PROMOUNT PLOW ACCESSORIES

## CAN-AM PROMOUNT EDGE MARKERS

- Help locate the edges of your plow.
- Height: 24" (60 cm).
- Sold in pairs.
- Compatible with Can-Am ProMount Steel and Flex2 Blades with or without Blade Extensions (except for the Can-Am ProMount Steel 54" (137 cm) Blades).

**Maverick X3, Maverick X3 MAX**

715004206

## CAN-AM PROMOUNT DRIFT CUTTERS\*

- Help keep snow in the plow.
- Dimensions: 17" x 13" (43.2 cm x 33 cm).
- Sold in pairs.
- Compatible with Can-Am ProMount Steel and Flex2 Blades with or without Blade Extensions (except for the Can-Am ProMount Steel 54" (137 cm) Blades).

**Maverick X3, Maverick X3 MAX**

715006258

## CAN-AM PROMOUNT PLASTIC WEAR BLADE\*

- To help prevent scratches on smooth driveways and markable surfaces.

**Maverick X3, Maverick X3 MAX**

66" (168 cm)

72" (183 cm)

715004482

715004483

## CAN-AM PROMOUNT BLADE EXTENSIONS

- Add 3" (8 cm) each side.
- Compatible with Can-Am ProMount Blades (except for Can-Am ProMount Steel 54" (137 cm) Blade).
- Longer Wear Blade can be installed to further extend the extra length already provided by the extensions.
- Compatible with Can-Am ProMount Steel and Flex2 Blades (except for the Can-Am ProMount Steel 54" (137 cm) Blades).

**Maverick X3, Maverick X3 MAX**

715004205 • Black

715005319 • Yellow

## **New** PLOW ANGLING SYSTEM

- Converts your plow system into an easy-to-control unit from the driver's seat.
- Allows you to have full up/down and left/right plow control at your fingertips by using the supplied joystick.
- Using one hand to control all plow motions will allow you to easily concentrate and manage your plowing tasks.
- Not compatible with Backcountry LT track kits on Maverick X3.

**Compatible with any ProMount Push Frame and Blade**

715006022



## PLOW ROLLER FAIRLEAD

- Larger diameter lower roller reduces wear on wire rope for plow application.
- Can be used with all ProMount plows.

**Maverick X3, Maverick X3 MAX**

705009222



## PLOW LIMIT SWITCH

(Not illustrated)

- For controlling the cable tension when over raising your plow system.
- Prevents winch, plow push frame and vehicle damage.
- Sensor relocated for optimal lift height.

**Maverick X3, Maverick X3 MAX**

715006259



## OEM TIRES

### X DS TIRE MAXXIS BIGHORN

Front - 29" x 9" x 14"  
705401674  
Rear - 29" x 11" x 14"  
705502604

### MAXXIS BIGHORN 2.0 TIRE

<u>Front - 28" x 9" x 14"</u> 705401592	<u>Front - 27" x 9" x 14"</u> 705401377    705400961 • C €
<u>Rear - 28" x 11" x 14"</u> 705502144	<u>Rear - 27" x 11" x 14"</u> 705502019    705501295 • C €

### MAXXIS LIBERTY TIRE

- Engineered for performance driving and to give you and your side-by-side freedom in a variety of terrains.
- 8-ply radial construction.

Maverick X3 Xrc  
30" x 10" x 14"                      32" x 10" x 14"  
705402143                              705402464



### X RS TIRE MAXXIS BIGHORN

Front & Rear - 30" x 10" x 14"  
705402082

## OEM RIMS

### 14" MAVERICK X3 X RC RIM

- Black with clear coat aluminum rim.

Maverick X3, Maverick X3 MAX  
705402254



### 14" MAVERICK X3 X RC BEADLOCK RIM

- Black aluminum rim with machined face and clear coat.
- Choice of beadlock color (not included).
- Needs 16 bolts (250000893) for installing the beadlock.

Maverick X3, Maverick X3 MAX

■ 705402207 • Black and machined  
■ 705402173 • Black



### 14" MAVERICK X3 BEADLOCK RIM

- Black with clear coat aluminum rim.
- Choice of beadlock color.
- Needs 16 bolts (250000893) for installing the beadlock.

Maverick X3, Maverick X3 MAX

<u>Front - 14" x 7"</u> • Offset = 55 mm • For Xrs = Front and rear 705401706	<u>Rear - 14" x 8"</u> • Offset = 76mm 705502286
--	--



### 14" MAVERICK X3 RIM

- Black with clear coat aluminum rim.

Maverick X3 & Maverick X3 MAX (Base models only)

<u>Front - 14" x 7"</u> • Offset = 55 mm 705401965	<u>Rear - 14" x 8"</u> • Offset = 76mm 705502493
--	--



### 14" MAVERICK X3 BEADLOCK

- Cast aluminum beadlock.
- Must be installed on Front Rim (705401706) and Rear Rim (705502286).

Maverick X3 & Maverick X3 MAX  
(X rs, X ds models only)

■ 705401709 • Black  
■ 705401913 • Gold





# RIDING GEAR





# CAN-AM OFF-ROAD RIDING GEAR LIMITED WARRANTY\*

**1-YEAR LIMITED WARRANTY ON SPORTSWEAR AND RIDING GEAR\*\***

**4-YEAR LIMITED WARRANTY ON HELMETS\*\***

\*Purchased at an authorized BRP dealership / distributor or on a BRP-authorized online store. Other exclusions may apply, see complete limited warranty or contact your Can-Am off-road authorized dealer.

\*\*Unless otherwise stipulated or required by law.

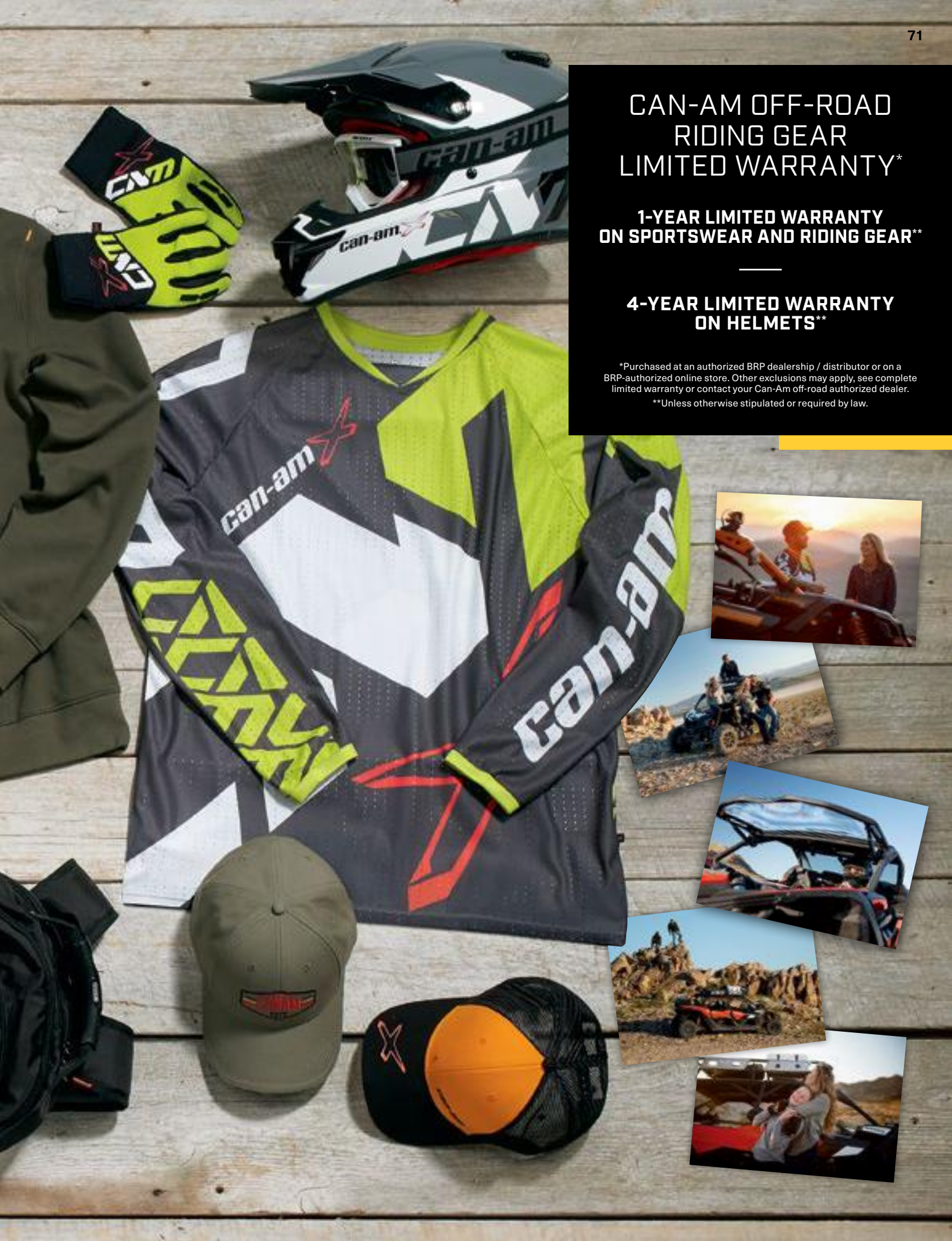



RIDING WITH STYLE AND PROTECTION. ROCK EVERYWHERE.





**New ZIPPED HOODIE**

60% Cotton,  
40% Polyester Fleece  
286709 • S-3XL  
Heather Grey (27),  
Black (90)

**New CAN-AM PULLOVER HOODIE**

60% Cotton,  
40% Polyester Fleece  
286708 • S-3XL  
Khaki (05), Black (90)

**CAN-AM SHIRT**

60% Cotton,  
40% Polyester  
454074 • S-3XL  
Khaki (05), Black (90)

**New LONG SLEEVE ORIGINAL TEE**

100% Cotton  
286717 • S-3XL  
White (01), Green (70)

**New ORIGINAL TEE**

100% Cotton  
286712 • XS-3XL  
Heather Grey (27),  
Black (90)

**New X-RACE TEE**

100% Cotton  
286714 • XS-3XL  
White (01),  
Black (90)

**New INTRUSION TEE**

100% Cotton  
286716 • XS-3XL  
Heather Grey (27),  
Green (70), Black (90)

**New LADIES' ORIGINAL TEE**

95% Cotton, 5% Spandex  
286715 • XS-2XL  
White (01), Black (90)

**New LADIES' X RACE TEE**

95% Cotton,  
5% Spandex  
286713 • XS-2XL  
Green (70), Black (90)



## ADVENTURE TEAM JERSEY

- Quick-dry, antibacterial, moisture-wicking fabric.
- Extended back for coverage while riding.
- Mesh fabric for extra ventilation underarms.
- Non-fading sublimated graphics.

100% Polyester

**454072 • S-3XL**  
Sunburst Yellow (96),  
Red (30)



## New X-RACE JERSEY

- Ultralight, quick-dry, antibacterial and moisture-wicking fabric.
- Mesh fabric for maximum breathability.
- Extended back for coverage while riding.
- Non-fading sublimated graphics.

100% Polyester.

**286710 • S-3XL**  
Orange (12), Green (70)



## New LADIES' TEAM JERSEY

- Semi-fitted cut specifically designed for ladies.
- Quick-dry, antibacterial, moisture-wicking fabric for maximum comfort.
- Mesh fabric for extra ventilation underarms.
- Non-fading sublimated graphics.

90% Polyester, 10% Spandex

**286711 • XS-2XL**  
Orange (12), Green (70)



## New ORIGINAL CAP

- Plastic adjustment strap at back.

100% Cotton

**286707 • One size • Khaki (05), Black (90)**



## New CLASSIC CAP

- Plastic adjustment strap at back.

100% Cotton

**447702 • One size • Charcoal Grey (09), Black (90)**



## New X RACE CAP

- Mesh at back.
- Plastic adjustment strap at back.

55% Cotton, 45% Polyester

**286705 • One size • Orange (12), Green (70), Black (90)**



## New INTRUSION FLAT CAP

- Mesh at back.
- Plastic adjustment strap at back.

100% Cotton

**286706 • One size • Black (90)**



# MUD GEAR

## MUD JACKET

- 100% waterproof PVC.
- Electronically-welded seams.
- Underarm and rear vent panels.
- 2 hand pockets.
- Elastic cuffs.
- Drawstring hood and hem.

Polyvinyl Chloride (PVC)

**286676 • S-2XL**  
Clear (00), Matte Black (93)



## MUD PANTS

- Oversized pants made of 100% waterproof PVC.
- Electronically-welded seams.
- Strategically placed ventilation.
- Side openings at bottom leg.

Polyvinyl Chloride (PVC)

**286128 • S-2XL**  
Clear (00), Matte Black (93)





## ENDURO

Designed for long rides and high adventure.

### FEATURES & BENEFITS

- Offers the dual experience of riding with a visor helmet plus the look and advantages of an MX helmet.
- Advanced plastic composite shell.
- Lockable, multi-positions and anti-scratch visor.
- Interchangeable retractable sun visor.
- Removable aerodynamic peak.
- Ultra-comfort and washable Dri-Lex<sup>+</sup> linings.
- Oversized and vented chin deflector.
- Adjustable air vents and exhausts.

### EX-2 ENDURO HELMET

Shell: Polycarbonate Composite  
448466 • XS-2XL • Black with graphics (94)

DOT ECE22.05



## XP-3

Superlight cross-style helmet: Feature-packed for exceptional performance, protection and comfort.

### FEATURES & BENEFITS

- 4-year limited warranty.
- Weight: ±1380 grams for size Large.
- Premium shell construction using superlight fiberglass and impact absorbing EPS liner.
- Aero-tuned fully adjustable visor system.
- Custom stainless grill design.
- Front and rear hi-max air vent system to maximize cooling.
- Removable, washable and replaceable CoolMax<sup>™</sup> moisture-wicking liner.
- Lightweight double-D chin strap.
- Triple certified: DOT, ECE and SNELL M2015.

### New XP-3 PRO CROSS X-RACE HELMET

Shell: Fiberglass  
448612 • XS-2XL  
Charcoal Grey (07),  
Green (70)

DOT Snell ECE22.05



Some products shown may not be available or homologated in your country. Contact your BRP dealer for local details.



## XC-4

Motocross style that combines lightweight construction, comfort and features beyond its price range. Value you can't ignore.

### FEATURES & BENEFITS

- 4-year limited warranty
- Weight: ±1420 g for size Large.
- Front and rear hi-max air vent system to maximize cooling effect.
- Shell construction is superlight polycarbonate with impact absorbing liner.
- Fully adjustable visor system.
- Removable, washable and replaceable moisture-wicking liner.
- Winter breath deflector (sold separately).
- Lightweight double-D chin strap.

### New XC-4 CROSS TEAM HELMET

- Durable multi-colored clear coated graphics.
- Can-Am branded.

Shell: Polycarbonate Composite

448608 • XS-2XL  
Charcoal Grey (07), Red (30)

DOT ECE22.05



## DUST MASKS

- Easily replaceable filters remove 99.9% of airborne dust, particles, pollen and odors.
- Made from soft yet durable neoprene material that fits snugly under helmets and goggles.
- XS/S fits most kids 12 and under, M/L fits most riders and XL/2XL fits larger frames (235+ lbs).
- Includes 2 replacement filters and a small storing pouch.
- Replacement filter (447719) available.

### CAN-AM ORIGIN DUST MASK

448524 • XS/S, M/L, XL/2XL • Black with graphics (94)



### CAN-AM VENTED DUST MASK

448525 • XS/S, M/L, XL/2XL • Black (90)



## COMMUNICATION SYSTEM

### SENA 30K BLUETOOTH COMM SYSTEM

- Bluetooth headset that operates on Sena's Mesh Intercom™ technology.
- The 30K has a new quick charge feature meaning just 20 minutes of charging gets riders an impressive 5 hours of Bluetooth intercom use, or 3 hours Mesh Intercom use.
- 2.4 GHz frequency, connecting to other riders in an entirely new way.
- Should one of the group's riders go out of range, the Mesh Intercom intelligently keeps the rest of the group in seamless communication, while actively searching to reconnect, should that rider come back within range.
- Using the private group mode, the 30K can pair in full duplex communication with up to 16 riders at a range up of to 1.2 miles (2 km).
- Sena 30K Audio Multitasking technology allows you to have a conversation via Adaptive Mesh-Networking technology while simultaneously enjoying Bluetooth operations such as streaming smartphone music, taking or making phone calls, or listening to turn-by-turn GPS navigation.

#### SINGLE PACK

448610 • One size • Black (90)

#### DUAL PACK

448611 • One size • Black (90)



\*Some models and accessories shown may not be available or homologated in your country. Contact your BRP dealer or local authorities for information.



## GOGGLES

### CAN-AM RACE SAND GOGGLES BY SCOTT

- Dust catcher vent foam.
- Custom painted frame and strap graphics.
- UV protected Lexan® lens with No Fog™ anti-fog lens treatment.
- Hypoallergenic multi-layer face foam.
- Durable and anti-slip full strap attachment.
- Extra clear lens in the box.
- Storing pouch included.
- Speed Strap attachment system compatible (sold separately).
- Tear-off and roll-off compatible (sold separately).

448638 • One size • Black (90)



### CAN-AM TRAIL GOGGLES BY SCOTT

- UV protected Lexan® lens.
- Hypoallergenic super-soft face foam.
- Speed Strap attachment system compatible (sold separately).
- Durable and anti-slip full strap attachment.
- Tear-off and roll-off compatible (sold separately).

448616 • One size • White (01), Red (30), Black (90)



## GLOVES

### New X-RACE GLOVES

- Air mesh panels for ventilation and mobility.
- Double Clarino® layer at palm and thumb for extra durability and comfort.
- Pre-curved design.
- Silicone fingertip for better grip.
- Hook-and-loop wrist closure system.

Shell: Air Mesh, Spandex, Clarino®



**MEN'S**

286718 • XS-2XL • Orange (12), Green (70)



**LADIES'**

286719 • S-2XL • Orange (12), Pink (36)



### ADVENTURE TEAM GLOVES

- Spandex construction for flexibility.
- Chamude palm.
- Pre-curved design.
- Slip-on gloves.
- Silicon print at inner fingers.

Shell: Spandex, Chamude, Polyester

446305 • S-3XL • Red (30)



## JUNIOR

### JUNIOR X CRUSH HELMET

- Multi-density EPS liner.
- Ultra-plush removable/washable liners.
- Adjustable visor to protect from the elements.
- Multiple air vents help keep you cool and dry.
- Lightweight double-D chin strap.
- Ski-Doo and Can-Am stickers in the box.
- Optional breath deflector (sold separately).

Shell: ABS

448506 • S, M, L • Black with graphics (94)



### New CAN-AM BUZZ GOGGLES BY SCOTT

- UV protected Lexan® lens.
- Hypoallergenic super-soft face foam.
- Durable and anti-slip full strap attachment.
- Speed Strap attachment system compatible (sold separately).

448620 • One size • Black (90)





## BAGS

## CAN-AM CARRIER DRY BACKPACK BY OGIO

- Completely waterproof rolltop construction.
- Reflective screen print.
- Airflow back panel keeps the rider cool.
- 2-way adjustable sternum strap.
- Dual-density shoulder straps for maximum comfort.
- Removable inner liner to allow bigger storage.
- Laptop and tablet sleeves.
- Organization panel with 2 zippered pockets.
- Dimensions: 20.5" H x 10.5" W x 6.75" D (52 cm x 27 cm x 17 cm).

100% Polyester

469544 • One size • Black (90)



## CAN-AM SLAYER GEAR BAG BY OGIO

- Large main compartment with easy access to all gear.
- Large separated boot pocket.
- Zippered accessory pocket.
- Easy grab handles for transport.
- Detachable shoulder strap.
- Heavy-duty reinforced base.
- Dimensions: 32" H x 16" W x 18" D (81 cm x 41 cm x 46 cm).

100% Polyester

469294 • One size • Black (90)



## CAN-AM URBAN BACKPACK BY OGIO

- Airport security friendly protective laptop compartment.
- Padded iPad™/tablet/e-reader pocket.
- Dual side water bottle/accessory holders.
- Fully adjustable ergonomic shoulder straps.
- Front pocket with 2 padded accessory compartments and slip pocket.
- Dimensions: 19.5" H x 13.5" W x 9.5" D (50 cm x 34 cm x 24 cm).

100% Polyester

469293 • One size  
Black (90)

## HOW TO MEASURE

- For best results, have someone else take measurements.
- Measure body in underwear.
- Tape must be snug but not tight.
- If measurements fall between two sizes, order the larger size.

- HEAD** Around your head, from the center of the forehead, above the ears and over the natural bump at the back of the head.
- ARM LENGTH** Let the hands hang down on the side in a slightly bent position. Measure from the center of the back of your neck, along the length of your arm, to the wrist.
- CHEST/ BUST** Measure under your arms, around the fullest part of your chest.
- WAIST** Measure around your natural waistline, keeping one finger between the tape and body.
- HIPS** Across the fullest part of the seat.
- INSEAM** Without shoes, from crotch to the floor.

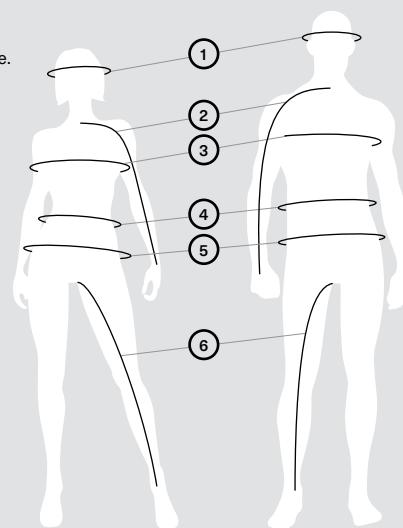

## WHAT CODE REPRESENTS YOUR SIZE?

1. Find your size.
2. The corresponding code is **THE CODE** you use to complete the part number on your order.  
Example: 440227\_\_90 Size: M = Code "06", therefore 4402270690

SIZE	CODE	SIZE	CODE	SIZE	CODE	SIZE	CODE	SIZE	CODE	SIZE	CODE
One Size	00	XL	12	4XLT	19	6	25	13	33	7-8	54
XS	02	XLT	13	5XL	88	7	27	14	34	10-12	49
S	04	2XL	14	1	20	8	28	16	35	14-16	50
M	06	2XL	15	2	21	9	29	18	78	S/M	72
MT	07	3XL	16	3	22	10	30	3-4	79	M/L	91
L	09	3XLT	17	4	23	11	31	5-6	52	L/XL	73
LT	10	4XL	18	5	24	12	32	6-8	48		

## RIDING GEAR &amp; SPORTSWEAR

## MEN'S-1.74 M - 1.83 M

	XS	S	M	L	XL	2XL	3XL
Chest	86-91	91-97	97-104	104-114	114-124	124-135	135-145
Waist	71-76	76-81	81-89	89-99	99-109	109-122	122-132
Hips (seat)	86-91	91-97	97-104	104-114	114-124	124-135	135-145
Arm length	76-79	79-81	81-84	84-86	86-89	89	89-91
Inseam	79-80	80-81	81	81	81	81	81

## LADIES'-1.60 M - 1.77 M

	XS	S	M	L	XL	2XL	3XL
Chest	81-86	86-91	91-99	99-107	107-117	117-127	127-137
Waist	66-71	71-76	76-84	84-91	91-102	102-112	112-122
Hips (seat)	89-94	94-99	99-107	107-114	114-124	124-135	135-145
Arm length	76	76	77	79	80	81	84
Inseam	76	76	76	76	76	76	76

## GLOVES (measure palm width)

## MEN'S

	S	M	L	XL	2XL	3XL
Palm (cm)	8	9	10	11,5	13	14

## LADIES'

	S	M	L	XL	2XL
Palm (cm)	7	8	9	10	11,5

## HELMETS

## MEN'S &amp; LADIES'

	XS	S	M	L	XL	2XL	3XL
Head (cm)	53-54	55-56	57-58	59-60	61-62	63-64	65-66

## JUNIOR

	S	M	L
Head (cm)	49-50	51-52	53-54

# KEEP YOUR CAN-AM VEHICLE PERFORMING AT ITS BEST

Remember what made you fall for a Can-Am vehicle? Precisely engineered. Rigorously tested. Factory approved. The ultimate off-road experience continues with Genuine Can-Am Parts, whether installed by our trusted network of trained dealers—or Do-It-Yourself installed in the comfort of your garage.

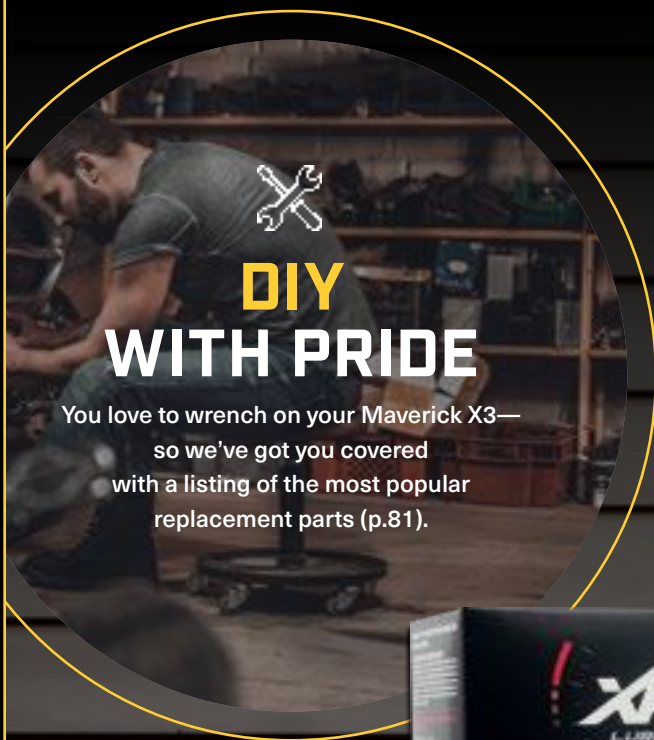

## DIY WITH PRIDE

You love to wrench on your Maverick X3—so we've got you covered with a listing of the most popular replacement parts (p.81).



\*For new genuine parts sold through BRP. Includes items installed by you or authorized BRP dealer. Other exclusions may apply, see complete limited warranty or contact your Can-Am off-road authorized dealer.

### ENGINE OIL CHANGE KIT

All-in-one solution that saves time and money. (p.87).



Visit the [can-amoffroad.com](http://can-amoffroad.com) Parts & Maintenance section to see the full line of Genuine Can-Am Parts.



## REGULAR MAINTENANCE ENSURES YOUR MAVERICK X3 PERFORMS AS YOU EXPECT

KEEP AN EYE ON THESE COMPONENTS\*



- ✓ **OIL FILTER** 420956123
- ✓ **ENGINE OIL** SEE P.87
- ✓ **FUEL FILTER** 709000330/709000100
- ✓ **AIR FILTER** 715900422/715002895
- ✓ **CVT AIR FILTER** 706600148
- ✓ **DRIVE BELT** 422280652
- ✓ **BRAKE PADS** SEE P.82
- ✓ **BOOT KITS** SEE P.82
- ✓ **WHEEL BEARINGS** 293350129
- ✓ **BALL JOINTS** 706203084/706202045
- ✓ **SPARK PLUG** 715900492
- ✓ **BATTERY** 410301203

\*Refer to periodic maintenance chart for proper intervals.

GENUINE CAN-AM MAINTENANCE PARTS

# GENUINE CAN-AM MAINTENANCE PARTS

### OIL FILTER

420956123



### PREMIUM AIR FILTER

- Premium quality filter.
- Prevents airborne contaminants from reaching your engine.
- Protects internal components against premature wear.

715900422



### PERFORMANCE AIR FILTER BY TWIN AIR<sup>†</sup>

- The best choice for the harshest conditions.
- Multiple staged oiled filtering foam for superior dust retaining capacity with high air flow.
- Washable and reusable.

715002895



### O-RING (DRAIN PLUG)

(Not illustrated)  
420552280

### O-RING (OIL FILTER COVER)

(Not illustrated)  
420650500

Complete Engine Oil Change Kit also available—See page 87.

### SPARK PLUG

715900492



### FUEL FILTER

(Not illustrated)  
709000330  
709000100 • (EVAP Models Only)

### FUEL PRE FILTER

(Not illustrated)  
270600113

### CVT AIR FILTER

(Not illustrated)  
706600148

Note: Please contact your dealer for suggested retail prices regarding Genuine Can-Am Parts.

PARTS & MAINTENANCE

**PERFORMANCE DRIVE BELT (100% PBO)**

- High-performance and unique belt technology.
- 100% cutting-edge PBO high-tensile strength polymer fiber construction.
- Designed for high-temperature robustness and prolonged durability.

**Maverick X3 Turbo R**

422280652

**CVT GASKET COVER**

(Not illustrated)

420450405

**DRIVEN PULLEY ADAPTOR**

(Not illustrated)

- Spreads the secondary clutch open for easy belt replacement.
- Locks engine at TDC for maintenance tasks.

708200720

**PULLER/LOCKING TOOL**

(Not illustrated)

- Allows to spread the secondary clutch open for easy belt replacement.

529000088

**CV BOOT KITS**

- Come with clamps and grease.
- Genuine BRP CV Boot Kits ensure absolute compatibility and a perfect fit.

715900450 • Rear Wheel &amp; Differential Side

705401354 • Front Wheel &amp; Differential Side

**METALLIC BRAKE PAD KIT**

- Built strong to last long – heavy-duty construction stands up to hard braking.
- Designed to handle demanding riding conditions with challenging braking environments such as mud and dunes.
- Created specifically for use with Can-Am vehicles.

**Contact your authorized dealer or visit our online store at [can-amoffroad.com](http://can-amoffroad.com)****Maverick X3, Maverick X3 MAX**

715900379 • Front Left

715900380 • Front Right

715900386 • Rear Left

715900387 • Rear Right

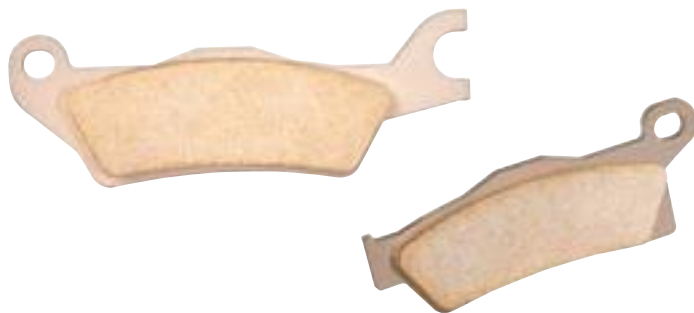
**YUASA<sup>†</sup> BATTERIES**

- Top of the line models from the leading preferred original equipment battery supplier in North America.

410301203 • 18 Amps. Wet • (YTX20L-BS)

**PERFORMANCE HALF SHAFT**

- High-performance design ideal for off-road use with superior wheel power and acceleration for racing, dunes and desert riding.
- Includes CVs, Shaft and Boots with the best suited geometry for your Can-Am vehicle.

**Please contact your dealer or visit our online store at [can-amoffroad.com](http://can-amoffroad.com) for suggested fitment.****WHEEL BEARINGS**

(Not illustrated)

- Sealed bearings for additional protection from water and dirt.

293350129

**BALL JOINTS**

- Robust design for off-road usage and sealed for prolonged durability.

706203084 • Upper

706202045 • Lower



Note: Please contact your dealer for suggested retail prices regarding Genuine Can-Am Parts.

Some products shown may not be available or homologated in your country. Contact your BRP dealer for local details.

# WHAT MAKES CAN-AM BELTS STAND OUT?



"I'VE TESTED EVERY BELT OUT THERE, AND CAN-AM'S DRIVE BELTS ARE WHAT I RELY ON TO WIN RACES."

**PHIL BLURTON**

2017-2018-2019 UTV World Championship Winner  
2017-2018 BITD UTV Pro Production Turbo Champion



## Consistent quality

We partner with the best manufacturers in the powersports industry to offer you unique drive belts with consistent quality.

## Prolonged durability

The 100% cutting-edge PBO high-tensile strength polymer fiber construction offers high-temperature robustness and prolonged durability.

## Tested performance

Our engineering teams have perfectly integrated and tested each drive belt to provide quick throttle response, powerful acceleration, top speed and consistent shifting performance.

## Custom calibration

We aim at delivering the highest levels of performance and longevity based on your vehicle's specific end-use and calibration.

## CAN-AM BELT CONSTRUCTION VS. COMPETITORS

### MODULUS & TENSILE STRENGTH

Based on Dynamometer testing, PBO surpasses Kevlar and Carbon Fiber materials in every way.

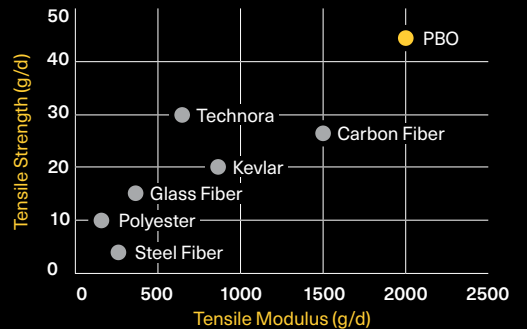

### DURABILITY COMPARISON

Compared to Can-Am's Performance Drive Belt.

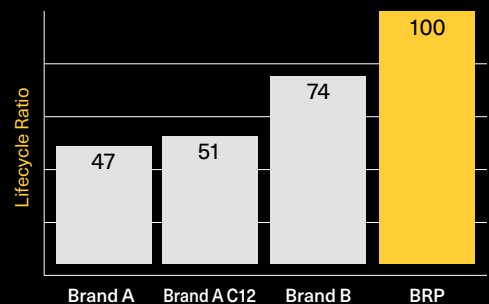

# XPS

## LUBRICANTS



### Kyle Chaney

**2017 TORC PRO MOD UTV CHAMPION  
AND MULTI-TIME GNCC CHAMPION**

Experienced short course and cross country champion racer Kyle Chaney relies on XPS to hold up to extreme race conditions.



### Phil Blurton

**2017-2018-2019 UTV WORLD CHAMPIONSHIP WINNER  
2017-2018 BITD UTV PRO PRODUCTION TURBO CHAMPION**

XPS lubricants are what get a naturally-gifted driver like Phil Blurton to the top of the podium.



**Hunter Miller**  
**2018 GNCC XC1 PRO TURBO UTV CHAMPION**  
 Multiple-time short course champion  
 Hunter Miller has won with XPS in all conditions.



# WHY XPS OIL IS THE PERFECT FIT FOR YOUR ROTAX ENGINE?

Just like you count on Can-Am to help you make the most of every terrain, you can trust XPS to ensure the long-lasting performance and durability of your Rotax engine.

## ULTIMATE PERFORMANCE

Engineered to match the advanced performance of Rotax engines.

## UNMATCHED RELIABILITY

Get the most out of every mile on every ride.

## MADE FOR THIS

Developed with Rotax engines to deliver the best performance and lubrication in all conditions.



XPS oil undergoes rigorous worst-case scenario testing, and as a result is the trusted lubricant of many Can-Am racers.

[can-amoffroad.com](http://can-amoffroad.com)

# ALL SET FOR YOUR RIDE?

## XPS 4T 10W-50 SYNTHETIC OIL

- Engineered for heavy-duty and high-performance 4-stroke engines, including turbocharged, supercharged and racing engines.
- Formulated using carefully selected and strenuously tested base stocks and custom additives.
- Offers thick film strength to protect bearings, and a proven high-temp detergency to minimize deposits, prevent shear, provide thermal stability, and combat fuel dilution to ensure maximum performance from your engine.

779234 • 1 quart / 946 ml

779235 • 1 US gallon / 3.785 L

## XPS 4T 0W-40 SYNTHETIC OIL

- Powersport formula with premium anti-wear and anti-corrosion additives.
- The best choice for high-performance snowmobile, ATV and SXS 4-stroke engine used in cold weather.
- Provides superior engine and transmission protection against heat, rust and corrosion.
- Delivers optimal performance in high and low temperature.

779139 • 1 quart / 946 ml

779140 • 1 US gallon / 3.785 L

## XPS 4T 5W-40 SYNTHETIC BLEND OIL

- Off-road formula with premium anti-wear and anti-corrosion additives.
- Designed for high-performance off-road, on-road and PWC 4-stroke engines, including turbo or supercharged powersports engines.
- Provides superior engine and transmission protection against rust and corrosion even in extreme conditions.

779133 • 1 quart / 946 ml

779134 • 1 US gallon / 3.785 L



Note: Please contact your dealer for suggested retail prices of XPS products.

Some products shown may not be available or homologated in your country. Contact your BRP dealer for local details.



## GET THE OIL CHANGE KIT THAT KEEPS YOUR ROTAX ROARING

Protecting your investment by changing your engine oil at regular intervals should be at the top of your maintenance to-do list. To make the task easier, we developed the XPS Engine Oil Change Kit for an all-in-one solution that saves time and money.

[can-amoffroad.com](http://can-amoffroad.com)



### ENGINE OIL CHANGE KIT

- Ultra-convenient "all-in-one" Engine Oil Change Kit saves time and money.
- Includes XPS Synthetic or Synthetic Blend Oil, oil filter, o-rings and washer.

**779256 • Synthetic Blend**  
(5W-40 450 cc or less (except Rally and DS ATVs))

**779257 • Full Synthetic**  
(0W-40 450 cc or less (except Rally and DS ATVs))

**779258 • Synthetic Blend** (5W-40 500 cc or more V-twin engine)

**779259 • Full Synthetic** (0W-40 500 cc or more V-twin engine)

**779252 • Full Synthetic** (10W-50 500 cc or more V-twin engine)

**779260 • Synthetic Blend** (5W-40 900 ACE)

**779261 • Full Synthetic** (10W-50 900 ACE)



**EXPERT CHOICE**

Love to DIY?  
Save money, time,  
and effort: everything  
you need for an oil  
change is in this box.

### SYNTHETIC GEAR OIL

- Uses custom additives to provide the best performance in Visco-Lok & Smart-Lok differentials.
- Allows higher loads, superior shear stability and reduced oxidation.
- Exceptional wear protection and superior performance at all operating temperatures.

**75W-90**

**779158 • 1 quart / 946 ml**

**75W-140**

**779160 • 1 quart / 946 ml**



### SYNTHETIC GREASE SUSPENSION

- Designed to work specifically with the components found in Can-Am vehicle suspensions.
- It is highly stable and offers optimal lubrication at both extreme cold and high temperatures while protecting suspension components from dirt and moisture, as well as corrosion under extreme washout conditions.

**779163 • 14 oz. / 400 g**



### ANTI-CORROSIVE LUBRICANT

- Multipurpose lubricant that can also be used to prevent rust, corrosion and moisture intrusion.
- It contains extreme pressure additives that work as an all-around lubricant for just about anywhere lubrication is needed.

**293600016 • 12 oz. / 340 g**



### EXTENDED LIFE PRE-MIXED COOLANT

- XPS Antifreeze/Coolant contains the correct dilution and the necessary additives to prevent corrosion and inhibit cavitation in BRP cooling systems.
- Long-life, 5-year formula specially formulated for BRP vehicles.
- Superior heat transfer.
- Ideal replacement for vehicles that normally use a 2-year antifreeze/coolant (green).

**779150 • 1 quart / 946 ml**



Note: Please contact your dealer for suggested retail prices of XPS products.



### DOT4 BRAKE FLUID

- Meets or exceeds all DOT3 and DOT4 brake fluid requirements.
- High-temperature formula resists fade, and also conditions seals and o-rings in braking system.

779151 • 12 oz. / 355 ml



### RACING BRAKE FLUID

- Exceeds DOT4 brake fluid requirements for extreme conditions and competition use.
- Extreme, 579-degree boiling point temperature is ideal for high-demand competition conditions to combat brake fade.
- Will not harm seals or braking system components.
- Should be added only to a clean/unfilled system to avoid dilution and diminished performance.
- Low-moisture formula slows water vapor absorption through multiple heat cycles.
- Recommended for use in Ski-Doo and Can-Am racing applications.

779152 • 12 oz. / 355 ml



### HIGH PERFORMANCE SUSPENSION FLUID

- A synthetic, fade-free formula for servicing FOX<sup>®</sup> shocks.
- Specially formulated for high-demand or racing application.
- Ultra high VI shock oil.
- Engineered viscosity for optimized performance with FOX<sup>®</sup> shocks valving.

779153 • 1 quart / 946 ml



### FUEL STABILIZER

- Ethanol-compatible and will stabilize fuel in your tank to keep it from breaking down and causing hard starting, throttle hesitation and poor run quality.
- Ethanol attracts moisture, and this product contains powerful anti-corrosion additives to protect fuel system components.
- Prevents problems associated with E10 fuels.

779171 • 8 oz. / 236 ml



### CARBON FREE FUEL TREATMENT

- Combination of a fuel treatment and a fuel system cleaner that can be used periodically to restore lost starting or throttle performance, as well as maintain fuel system integrity and keep internal engine parts clean.
- It treats fuel for storage and addresses the moisture problems inherent in today's Ethanol-blended fuels, keeping ferrous and soft metal parts clean and free of corrosion.
- Uses patented, state-of-the-art additives.
- Cleans valves, sticky rings and combustion chamber.

779169 • 12 oz. / 355 ml



### FUEL TREATMENT CARBURETOR CLEANER

- Complete fuel treatment specially formulated to prevent small engine problems caused by Ethanol-blended fuels.
- It removes fuel system gum and varnish that may have accumulated during storage, stabilizes fuel against breakdown for 12 months or more, and adds corrosion protection from moisture for short- and long-term storage.
- It also helps restore throttle response and easy starting.
- It can be used periodically to maintain fuel system integrity, keep carburetor jets clean, and also combat moisture problems caused by Ethanol-blended fuels to keep ferrous and soft metal parts clean and free of corrosion.

779172 • 12 oz. / 355 ml



Note: Please contact your dealer for suggested retail prices of XPS products.

Some products shown may not be available or homologated in your country. Contact your BRP dealer for local details.

EXPLORE AN ENTIRE WORLD OF ADVENTURE WITH ALL OF OUR BRP PRODUCTS. [BRP.COM](http://BRP.COM)



**ski-doo LYNX SEA-DOO can-am ROTAX ALUMACRAFT Manitou Evinrude**





WE'RE  
BUILT  
FOR  
THIS



830201167

©2019 Bombardier Recreational Products Inc. (BRP). All rights reserved. ®, ™ and the BRP logo are trademarks of BRP or its affiliates.

A BRP BRAND

